

# APPLIED RESEARCH EUROPE GmbH

## CHROMATOGRAPHY ACCESSORIES AND SUPPLIES

BlackLine Fittings  
Capillaries, Precut Tubing  
Sample Loops  
High Pressure Fittings  
Low and Medium Pressure Fittings  
Filter Discs  
Solvent Filters  
Columns  
Tools  
Accessories

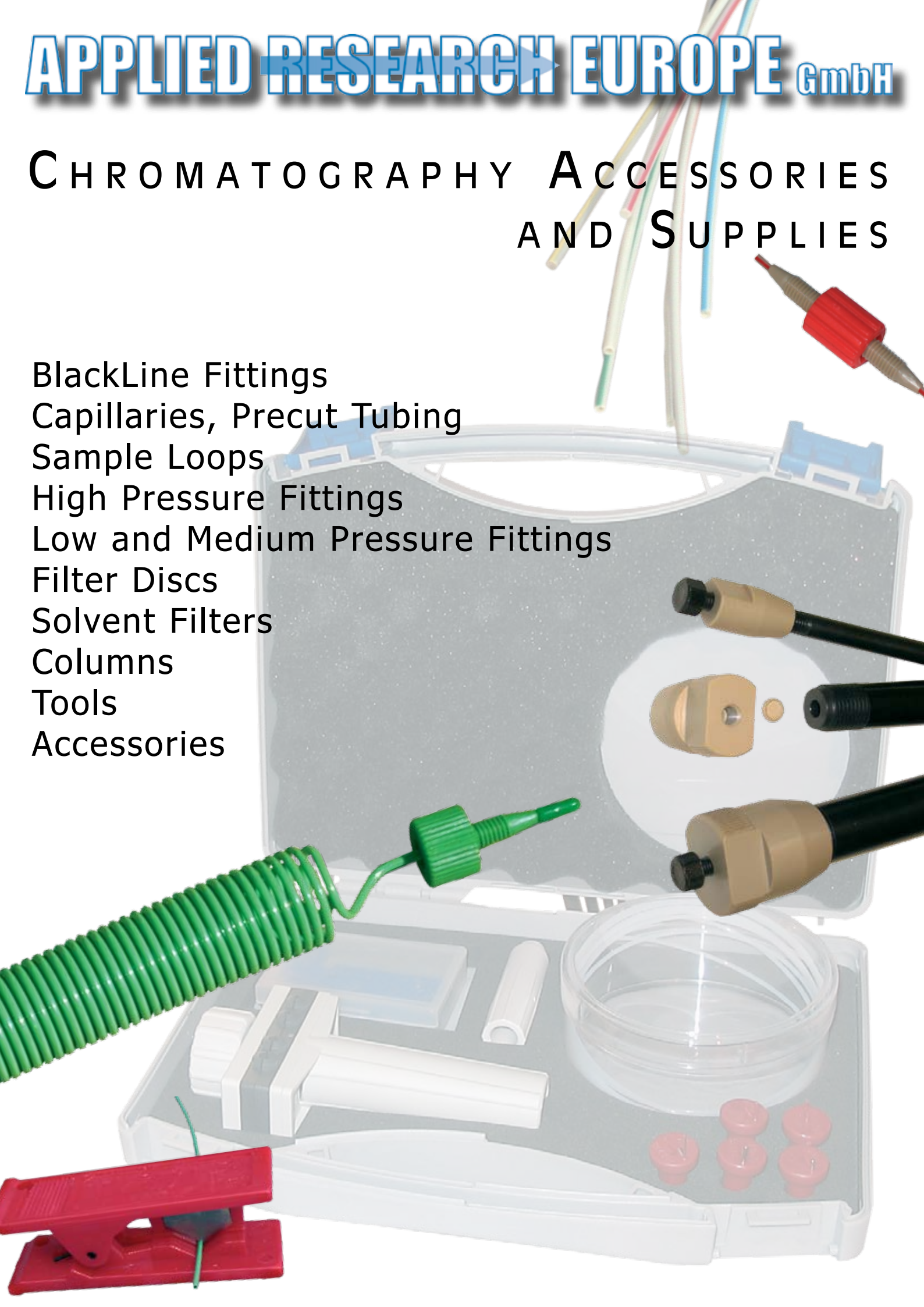

FOR INFORMATION:

info@appliedresearch.de  
www.appliedresearch.de

TO PLACE AN ORDER:

order@appliedresearch.de

Golmer Str. 18A  
DE 13585 Berlin  
Germany

Tel +49 - (0)30 - 37 888 754  
Fax +49 - (0)30 - 37 888 755

Applied Research Europe GmbH is the new name of a well known German company, Scientific Metal Equipment GmbH (SME).

For many years SME has been working in the field of chromatography, beginning with the manufacturing and supply of metallic components to the chromatographic industry of Germany.

During the years SME became a more prominent supplier not only for metal products but also accessories made of polymeric material.

Applied Research Europe GmbH began as a German company focusing on the German market. Further developments during the last years made us change our policy and you will now find our products in every corner of the world.

Recently, new product lines have been added to this complete catalog with all the accessories and components needed for chromatography. All items are shipped from a one-stop shopping location in the heart of Europe.

We serve distributors as well as OEM customers which are welcome to inquire about our existing products and the development of new ones.

We are dedicated to fast and reliable service, competitive pricing and high quality production.

We hope you like our product line. If there are any requests for products which we do not carry in the catalog, please do not hesitate to contact us.

We are looking forward working with you,  
Helmut Müller and Christian Wegner



# CONTENT OF PRODUCTS

## TUBING AND CAPILLARIES

PAGE 4 - 9

PEEK	4
FlexiTube	5
Sample Loops PEEK & SS	6
Stainless Tube / Precuts	7
PTFE Tube / Reaction Coils	8
PFA / FEP / ETFE	9

## FITTINGS

PAGE 10-19

BlackLine PEEK Fittings	10- 13
High Pressure Fittings PEEK	14
High Pressure Fittings SS	15
Low and Medium Pressure Fittings	16-18
Low and Medium Pressure Adapters	19

## FILTERS AND FRITS

PAGE 20-25

Biocompatible Filter Discs (PAT / Ti)	20
SS Filter Discs	21-22
Hastelloy Filter Discs	22
Solvent Filters SS	23
InLine Filters SS	24
Solvent Filters Polymer	24
InLine Filters PEEK	25
PoroMet Frits	25

## HPLC COLUMNS

PAGE 26-29

PEEK Columns	26
SS Columns	27-29
Column Accessories	29

## TOOLS

PAGE 30-31

## ACCESSORIES

PAGE 32-35

Solvent Reservoirs	32
GasTight Tubing	32
Variable Backpressure Regulator	32
Solvent Recycler	33
Degasser	33
Injection Valves	34
Switching Valves	35

## APPENDICES

PAGE 36-38

Conversion Tables and Diagrams	36-38
--------------------------------	-------



# TUBING AND CAPILLARIES

## INFO:

All of [Applied Research](#) PEEK tubing is extruded from virgin PEEK made by Victrex, the original manufacturer of PEEK material. We do not add any additives to the original PEEK material, except for color particles in the solid colored tubing. Striped colored tubing consists of natural PEEK tubing where a stripe will be added to the outside of the tubing after extrusion. We always recommend using striped or natural tubing, because PEEK is not stable to all chemicals. Some solvents may react with the PEEK wall material and dissolve the color particles. Be aware of the limitations of PEEK material concerning solvents, temperature and pressure. If you are unsure, please get advise before using PEEK tubing.

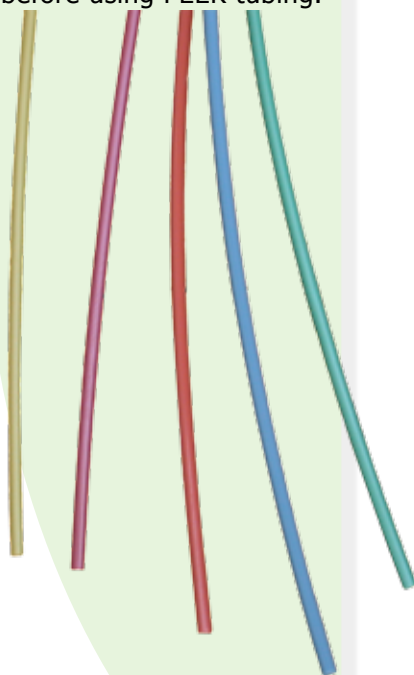

## PEEK TUBING

### ULTRA-T (EXTRA-LOW TOLERANCE) +/- 0.025 MM ID AND OD

#### DOUBLE STRIPED COLOR

P/N	Description	Pressure (bar/psi)
41.159.006.90	Tubing, PEEK, 1/16" OD x 0.064 mm ID, natural	435 / 6300
41.159.013.91	Tubing, PEEK, 1/16" OD x 0.13 mm ID, red	420 / 6100
41.159.018.92	Tubing, PEEK, 1/16" OD x 0.18 mm ID, yellow	400 / 5800
41.159.025.93	Tubing, PEEK, 1/16" OD x 0.25 mm ID, blue	385 / 5600

### STANDARD TOLERANCE +/- 0.05 MM ID AND OD

#### STRIPED COLOR

P/N	Description	Pressure (bar/psi)
41.159.013.01	Tubing, PEEK, 1/16" OD x 0.13 mm ID, red	420 / 6100
41.159.018.02	Tubing, PEEK, 1/16" OD x 0.18 mm ID, yellow	400 / 5800
41.159.025.03	Tubing, PEEK, 1/16" OD x 0.25 mm ID, blue	385 / 5600
41.159.050.04	Tubing, PEEK, 1/16" OD x 0.50 mm ID, orange	350 / 4500
41.159.075.05	Tubing, PEEK, 1/16" OD x 0.75 mm ID, green	240 / 3500
41.159.100.06	Tubing, PEEK, 1/16" OD x 1.0 mm ID, grey	165 / 2400
41.159.140.07	Tubing, PEEK, 1/16" OD x 1.4 mm ID, black	50 / 750

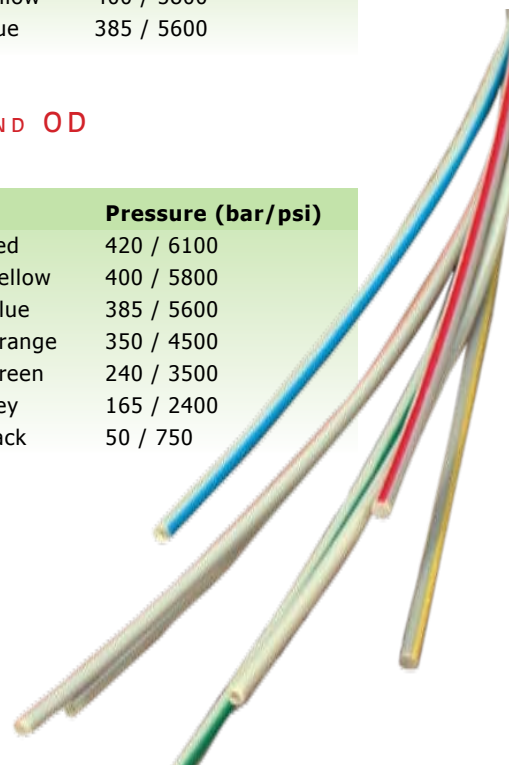

## ALL NATURAL

P/N	Description	Pressure (bar/psi)
41.036.007.00	Tubing, PEEK, 360 µm OD x 75 µm ID	355 / 5200
41.079.013.00	Tubing, PEEK, 1/32" OD x 0.13 mm ID	380 / 5500
41.079.018.00	Tubing, PEEK, 1/32" OD x 0.18 mm ID	350 / 5100
41.079.025.00	Tubing, PEEK, 1/32" OD x 0.25 mm ID	310 / 4500
41.318.075.00	Tubing, PEEK, 1/8" OD x 0.75 mm ID	345 / 5000
41.318.159.00	Tubing, PEEK, 1/8" OD x 1/16" ID	220 / 3200
41.318.200.00	Tubing, PEEK, 1/8" OD x 2.0 mm ID	165 / 2400
41.635.318.00	Tubing, PEEK, 1/4" OD x 1/8" ID	225 / 3300



## SOLID COLOR

P/N	Description	Pressure (bar/psi)
41.159.013.51	Tubing, PEEK, 1/16" OD x 0.13 mm ID, red	420 / 6100
41.159.018.52	Tubing, PEEK, 1/16" OD x 0.18 mm ID, yellow	400 / 5800
41.159.025.53	Tubing, PEEK, 1/16" OD x 0.25 mm ID, blue	385 / 5600
41.159.050.54	Tubing, PEEK, 1/16" OD x 0.50 mm ID, orange	350 / 4500
41.159.075.55	Tubing, PEEK, 1/16" OD x 0.75 mm ID, green	240 / 3500

**Note:** The data collected in column 'Pressure' show the recommended permanent maximum working pressure at room temperature for non-destructive solvents. Change of solvents and temperature may result in lowered mechanical stability. Keep in mind that tight bends of the tubing, use of wrong tools for cutting and bad connections may result in mechanical damage to the tube and by this reduce the pressure stability.

# TUBING AND CAPILLARIES

INFO:

## PEEK FLEXITUBE

Type	Coil Resting Position	Coil Extended Position	FlexiTube Fully Extended	FlexiTube Total Length
02	10	30	330	710
03	20	120	420	945
04	35	200	500	1225
05	50	300	600	1585
06	100	400	700	2060
07	150	500	900	3150
08	170	8000	1100	4710
09	225	1100	1400	6100
10	250	1300	1600	6930

## DOUBLE STRIPED COLOR CODED PEEK TUBING ULTRAT (EXTRA-LOW TOLERANCE)

Type	Inner Diameter			
	0.064 mm	0.13 mm	0.18 mm	0.25 mm
02	41.159.006.9002	41.159.013.9102	41.159.018.9202	41.159.025.9302
03	41.159.006.9003	41.159.013.9103	41.159.018.9203	41.159.025.9303
04	41.159.006.9004	41.159.013.9104	41.159.018.9204	41.159.025.9304
05	41.159.006.9005	41.159.013.9105	41.159.018.9205	41.159.025.9305
06	41.159.006.9006	41.159.013.9106	41.159.018.9206	41.159.025.9306
07	41.159.006.9007	41.159.013.9107	41.159.018.9207	41.159.025.9307
08	41.159.006.9008	41.159.013.9108	41.159.018.9208	41.159.025.9308
09	41.159.006.9009	41.159.013.9109	41.159.018.9209	41.159.025.9309
10	41.159.006.9010	41.159.013.9110	41.159.018.9210	41.159.025.9310

## STRIPED COLOR CODED PEEK TUBING

Type	Inner Diameter				
	0.13 mm	0.18 mm	0.25 mm	0.50 mm	0.75 mm
02	41.159.013.0102	41.159.018.0202	41.159.025.0302	41.159.050.0402	41.159.075.0502
03	41.159.013.0103	41.159.018.0203	41.159.025.0303	41.159.050.0403	41.159.075.0503
04	41.159.013.0104	41.159.018.0204	41.159.025.0304	41.159.050.0404	41.159.075.0504
05	41.159.013.0105	41.159.018.0205	41.159.025.0305	41.159.050.0405	41.159.075.0505
06	41.159.013.0106	41.159.018.0206	41.159.025.0306	41.159.050.0406	41.159.075.0506
07	41.159.013.0107	41.159.018.0207	41.159.025.0307	41.159.050.0407	41.159.075.0507
08	41.159.013.0108	41.159.018.0208	41.159.025.0308	41.159.050.0408	41.159.075.0508
09	41.159.013.0109	41.159.018.0209	41.159.025.0309	41.159.050.0409	41.159.075.0509
10	41.159.013.0110	41.159.018.0210	41.159.025.0310	41.159.050.0410	41.159.075.0510

## SOLID COLOR CODED PEEK TUBING

Type	Inner Diameter				
	0.13 mm	0.18 mm	0.25 mm	0.50 mm	0.75 mm
02	41.159.013.5102	41.159.018.5202	41.159.025.5302	41.159.050.5402	41.159.075.5502
03	41.159.013.5103	41.159.018.5203	41.159.025.5303	41.159.050.5403	41.159.075.5503
04	41.159.013.5104	41.159.018.5204	41.159.025.5304	41.159.050.5404	41.159.075.5504
05	41.159.013.5105	41.159.018.5205	41.159.025.5305	41.159.050.5405	41.159.075.5505
06	41.159.013.5106	41.159.018.5206	41.159.025.5306	41.159.050.5406	41.159.075.5506
07	41.159.013.5107	41.159.018.5207	41.159.025.5307	41.159.050.5407	41.159.075.5507
08	41.159.013.5108	41.159.018.5208	41.159.025.5308	41.159.050.5408	41.159.075.5508
09	41.159.013.5109	41.159.018.5209	41.159.025.5309	41.159.050.5409	41.159.075.5509
10	41.159.013.5110	41.159.018.5210	41.159.025.5310	41.159.050.5410	41.159.075.5510

**Note:** Tolerances and pressure stability for PEEK tubing and capillaries are described in the PEEK capillary section.



# TUBING AND CAPILLARIES

## PEEK AND SS SAMPLE LOOPS

### INFO:

Applied Research PEEK sample loops with volumes of 1 to 20  $\mu\text{l}$  are manufactured of tubing with the closest tolerance (OD and ID:  $\pm 0.025$  mm) available on the market, the UltraT-PEEK tube, which guarantees the smallest volume deviation possible.

ID tolerance of PEEK tubing used for sample loops  $>20$   $\mu\text{l}$  is  $\pm 0.05$  mm.

We offer sample loops with other volumes on request.

All of Applied Research SS tubing is welded and annealed. The tubing is tested according to EN 10204/3.1B. Applied Research SS tubing is cut using EDC (electronic discharge) techniques to achieve square and burr-free ends for zero-dead volume connections.

ID tolerance of SS tubing used for sample loops is  $\pm 0.025$  mm.

We offer sample loops with other volumes on request.

### PEEK SAMPLE LOOPS

Volume	Capillary ID	Cheminert/Rheodyne	VICI Valco
1 $\mu\text{l}$	0.06 mm	41.001.006-10.1	41.001.006-10.2
2 $\mu\text{l}$	0.06 mm	41.002.006-10.1	41.002.006-10.2
5 $\mu\text{l}$	0.18 mm	41.005.018-12.1	41.005.018-12.2
10 $\mu\text{l}$	0.25 mm	41.010.025-13.1	41.010.025-13.2
20 $\mu\text{l}$	0.25 mm	41.020.025-13.1	41.020.025-13.2
50 $\mu\text{l}$	0.50 mm	41.050.050-14.1	41.050.050-14.2
100 $\mu\text{l}$	0.50 mm	41.100.050-14.1	41.100.050-14.2
250 $\mu\text{l}$	0.75 mm	41.250.075-15.1	41.250.075-15.2
500 $\mu\text{l}$	0.75 mm	41.500.075-15.1	41.500.075-15.2
1000 $\mu\text{l}$	0.75 mm	41.1000.075-15.1	41.1000.075-15.2



### SS SAMPLE LOOPS

Volume	Capillary ID	Cheminert/Rheodyne	VICI Valco
5 $\mu\text{l}$	0.18 mm	46.005.018-02.1	46.005.018-02.2
10 $\mu\text{l}$	0.25 mm	46.010.025-03.1	46.010.025-03.2
20 $\mu\text{l}$	0.25 mm	46.020.025-03.1	46.020.025-03.2
50 $\mu\text{l}$	0.50 mm	46.050.050-04.1	46.050.050-04.2
100 $\mu\text{l}$	0.50 mm	46.100.050-04.1	46.100.050-04.2
250 $\mu\text{l}$	0.75 mm	46.250.075-05.1	46.250.075-05.2
500 $\mu\text{l}$	0.75 mm	46.500.075-05.1	46.500.075-05.2
1000 $\mu\text{l}$	0.75 mm	46.1000.075-05.1	46.1000.075-05.2
2ml	1.0 mm	46.2000.100-06.1	46.2000.100-06.2
5ml	1.0 mm	46.5000.100-06.1	46.5000.100-06.2



# TUBING AND CAPILLARIES

## SS TUBING AND PRECUT TUBING

### INFO:

All of [Applied Research](#) SS tubing is welded and annealed. The tubing is tested according to EN 10204/3.1B

Tolerances for SS tubing and capillaries is as follows: up to  
 2.0 mm: +/- 0.025mm  
 2.0 mm and above: +/- 0.05 mm

### SS-TUBING

P/N	Description
46.079.018.00	Tubing, SS, 1/32" OD x 0.18 mm ID
46.159.013.00	Tubing, SS, 1/16" OD x 0.13 mm ID
46.159.018.00	Tubing, SS, 1/16" OD x 0.18 mm ID
46.159.025.00	Tubing, SS, 1/16" OD x 0.25 mm ID
46.159.050.00	Tubing, SS, 1/16" OD x 0.50 mm ID
46.159.075.00	Tubing, SS, 1/16" OD x 0.75 mm ID
46.159.100.00	Tubing, SS, 1/16" OD x 1.00 mm ID
46.318.159.00	Tubing, SS, 1/8" OD x 1/16" ID
46.318.210.00	Tubing, SS, 1/8" OD x 2.1 mm ID
46.635.460.00	Tubing, SS, 1/4" OD x 4.6 mm ID

### SS-PRECU TUBING

	100 mm	250 mm	300 mm	500 mm
P/N 0.13 mm ID	46.159.013-10	46.159.013-25	46.159.013-30	46.159.013-50
P/N 0.18 mm ID	46.159.018-10	46.159.018-25	46.159.018-30	46.159.018-50
P/N 0.25 mm ID	46.159.025-10	46.159.025-25	46.159.025-30	46.159.025-50
P/N 0.50 mm ID	46.159.050-10	46.159.050-25	46.159.050-30	46.159.050-50
P/N 0.75 mm ID	46.159.075-10	46.159.075-25	46.159.075-30	46.159.075-50
P/N 1.00 mm ID	46.159.100-10	46.159.100-25	46.159.100-30	46.159.100-50

All of [Applied Research](#) SS tubing is welded and annealed. The tubing is tested according to EN 10204/3.1B [Applied Research](#) SS tubing is cut using EDC (electronic discharge) techniques to achieve square and burr-free end for zero-dead volume connections.



Tolerances for SS tubing and capillaries is as follows:  
 up to 2.0 mm: +/- 0.025mm  
 2.0 mm and above: +/- 0.05 mm  
 length: +/- 0.10 mm

We offer other length and ID on request.

# TUBING AND CAPILLARIES

## PTFE TUBING (POLYTETRAFLUORETHYLEN)

### INFO:

All Applied Research PTFE tubings and capillaries are extruded from virgin PTFE manufactured exclusively by Dupont, the original manufacturer of PTFE material. We do not add any additives to the original PTFE material, except for color particles in the solid colored tubing. PTFE tubing and capillaries are widely used in all low-pressure laboratory applications. Please be aware that all PTFE tubing does contain micro-pores in the tubing wall. These micro-pores allow a quick air exchange. This is of special consideration for degassed and oxygen-sensitive solvents.

Tolerances for PTFE tubing and capillaries is as follows:  
 up to 2.0 mm: +/- 0.10 mm  
 2.0 mm and above: +/- 0.20 mm

### PTFE TUBING (POLYTETRAFLUORETHYLEN)

#### ALL NATURAL

P/N	Description	Pressure (bar/psi)
42.159.018.00	Tubing, PTFE, 1/16" OD x 0.18 mm ID	60 / 850
42.159.025.00	Tubing, PTFE, 1/16" OD x 0.25 mm ID	55 / 800
42.159.050.00	Tubing, PTFE, 1/16" OD x 0.50 mm ID	50 / 725
42.159.075.00	Tubing, PTFE, 1/16" OD x 0.75 mm ID	35 / 510
42.159.100.00	Tubing, PTFE, 1/16" OD x 1.00 mm ID	25 / 365
42.200.170.00	Tubing, PTFE, 2.00 mm OD x 1.70 mm ID	10 / 150
42.318.159.00	Tubing, PTFE, 1/8" OD x 1/16" ID	35 / 510
42.318.240.00	Tubing, PTFE, 1/8" OD x 2.40 mm ID	20 / 290
42.635.475.00	Tubing, PTFE, 1/4" OD x 4.75 mm ID	20 / 290
42.400.300.00	Tubing, PTFE, 4.00 mm OD x 3.00 mm ID	20 / 290

#### SOLID COLOR

P/N	Description	Pressure (bar/psi)
42.159.025.51	Tubing, PTFE, 1/16" OD x 0.25 mm ID, blue	55 / 800
42.159.050.52	Tubing, PTFE, 1/16" OD x 0.50 mm ID, orange	50 / 725
42.159.075.53	Tubing, PTFE, 1/16" OD x 0.75 mm ID, green	35 / 510
42.159.025.57	Tubing, PTFE, 1/16" OD x 0.25 mm ID, black	55 / 725
42.159.050.57	Tubing, PTFE, 1/16" OD x 0.50 mm ID, black	50 / 725

### KNITTED REACTION COILS; PTFE TUBING

P/N	P/N	P/N	length
ID 0.25 mm	ID 0.50 mm	ID 0.75 mm	
42.159.025-1	42.159.050-1	42.159.075-1	1 m
42.159.025-2	42.159.050-2	42.159.075-2	2 m
42.159.025-4	42.159.050-4	42.159.075-4	4 m
42.159.025-10	42.159.050-10	42.159.075-10	10 m
42.159.025-20	42.159.050-20	42.159.075-20	20 m



**Note:** The data collected in column 'Pressure' show the recommended permanent maximum working pressure at room temperature for non-destructive solvents. Change of solvents and temperature may result in lowered mechanical stability. Keep in mind that tight bends of the tubing, use of wrong tools for cutting and bad connections may result in mechanical damage to the tube and by this reduce the pressure stability.



# TUBING AND CAPILLARIES

## PFA - FEP - ETFE TUBING

### INFO:

#### PFA TUBING (PERFLUORALKOXY)

P/N	Description	Pressure (bar/psi)
43.159.050.00	Tubing, PFA, 1/16" OD x 0.50 mm ID	100 / 1450
43.159.075.00	Tubing, PFA, 1/16" OD x 0.75 mm ID	75 / 1075
43.159.100.00	Tubing, PFA, 1/16" OD x 1.00 mm ID	55 / 800
43.318.159.00	Tubing, PFA, 1/8" OD x 1/16" ID	75 / 1075

All of [Applied Research](#) PFA capillaries are extruded from virgin PFA manufactured exclusively by DuPont. We do not add any additives to the original PTFE material, except for color particles in the solid colored tubing. PFA tubing and capillaries does not contain micro-pores in the tubing wall to the same extent as PTFE tubing and capillaries.

#### FEP TUBING (FLOURINATED ETHYLENE PROPYLENE)

P/N	Description	Pressure (bar/psi)
44.159.025.00	Tubing, FEP, 1/16" OD x 0.25 mm ID	115 / 1650
44.159.050.00	Tubing, FEP, 1/16" OD x 0.50 mm ID	95 / 1375
44.159.075.00	Tubing, FEP, 1/16" OD x 0.75 mm ID	75 / 1075
44.159.100.00	Tubing, FEP, 1/16" OD x 1.00 mm ID	50 / 725
44.318.159.00	Tubing, FEP, 1/8" OD x 1/16" ID	70 / 1000
44.635.435.00	Tubing, FEP, 1/4" OD x 4.35 mm ID	45 / 650

All of [Applied Research](#) FEP capillaries are extruded from virgin FEP. FEP is mostly useful in ion-chromatography applications. Do not use FEP above 80°C.

#### ETFE TUBING (TEFZEL)

P/N	Description	Pressure (bar/psi)
45.080.025.00	Tubing, ETFE, 1/32" OD x 0.25 mm ID	150 / 2150
45.159.018.00	Tubing, ETFE, 1/16" OD x 0.18 mm ID	200 / 2900
45.159.025.00	Tubing, ETFE, 1/16" OD x 0.25 mm ID	185 / 2675
45.159.050.00	Tubing, ETFE, 1/16" OD x 0.50 mm ID	150 / 2175
45.159.075.00	Tubing, ETFE, 1/16" OD x 0.75 mm ID	115 / 1625
45.159.100.00	Tubing, ETFE, 1/16" OD x 1.00 mm ID	85 / 1225
45.318.159.00	Tubing, ETFE, 1/8" OD x 1/16" ID	110 / 1600

All of [Applied Research](#) ETFE tubings and capillaries are extruded from virgin ETFE. We do not add any additives to the original ETFE material. ETFE tubing and capillaries are widely used in all low- and medium pressure laboratory applications due to the relatively high burst-pressure. Please be aware that ETFE tubing is not resistant to all chemicals. Some organic solvents may cause swelling and reduce the pressure stability.

Tolerances for PFA / FEP / ETFE tubing and capillaries is as follows:  
 up to 2.0 mm: +/- 0.05mm  
 2.0 mm and above: +/- 0.10 mm

**Note:** The data collected in column 'Pressure' show the recommended permanent maximum working pressure at room temperature for non-destructive solvents. Change of solvents and temperature may result in lowered mechanical stability. Keep in mind that tight bends of the tubing, use of wrong tools for cutting and bad connections may result in mechanical damage to the tube and by this reduce the pressure stability.

# BLACKLINE PEEK FITTINGS

## BLACKLINE ONE-PIECE FITTINGS AND CONNECTORS, HIGH-PRESSURE, 10-32 THREAD

### INFO:

BlackLine PEEK fittings and accessories are made of Carbon PEEK. Carbon PEEK ensures unsurpassed chemical stability and mechanical durability. We recommend the use of [Applied Research](#) BlackLine PEEK components for all chromatographic applications.

### 10-32 THREAD

P/N	Description (10 pcs/pkg)
51.1.1.062.150	Fitting, PEEK, BlackLine, one-piece fingertight small-head, 10-32
51.1.1.062.100	Fitting, PEEK, BlackLine, one-piece fingertight, 10-32
51.1.1.062.200	Fitting, PEEK, BlackLine, one-piece hex head, 10-32
51.1.1.062.300	Fitting, PEEK, BlackLine, one-piece wing, 10-32
51.1.1.062.240	Fitting, PEEK, BlackLine, one-piece fingertight narrow hex-head, 10-32

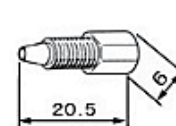
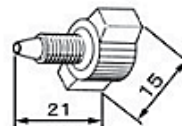
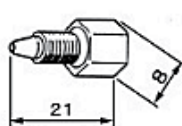
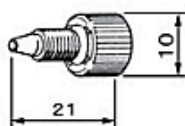
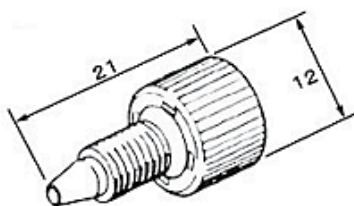

P/N	Description (2 pcs/pkg)
51.1.20062.05-00	Union, PEEK, BlackLine, 10-32, bore 0.50 mm, body only
51.1.20062.05-01	Union, PEEK, BlackLine, 10-32, bore 0.50 mm, complete
51.1.30062.05-00	Tee, PEEK, BlackLine, 10-32, bore 0.50 mm, body only
51.1.30062.05-01	Tee, PEEK, BlackLine, 10-32, bore 0.50 mm, complete
51.1.40062.05-00	Cross, PEEK, BlackLine, 10-32, bore 0.50 mm, body only
51.1.40062.05-01	Cross, PEEK, BlackLine, 10-32, bore 0.50 mm, complete

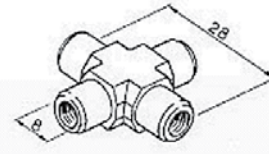
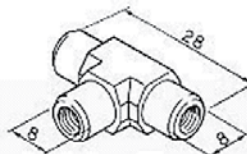
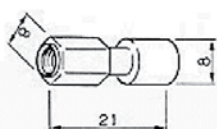

# BLACKLINE PEEK FITTINGS

## BLACKLINE FITTINGS AND CONNECTORS, M6 THREAD

INFO:

### M6 THREAD

#### For use with 1/16" capillary

P/N	Description (10 pcs/pkg)
51.1.1.06062-03	Ferrule, ETFE, BlackLine, M6, 1/16" capillary
51.8.1.06062-02	Nut, POM, BlackLine, M6, 1/16" capillary
51.1.1.06062-01	Nut, PEEK, BlackLine, M6, 1/16" capillary



P/N	Description (10 pcs/pkg)
51.1.1.06020-03	Ferrule, ETFE, BlackLine, M6, 2 mm capillary
51.8.1.06020-02	Nut, POM, BlackLine, M6, 2 mm capillary
51.1.1.06020-01	Nut, PEEK, BlackLine, M6, 2 mm capillary



#### For use with 3 mm capillary

P/N	Description (10 pcs/pkg)
51.1.1.06030-03	Ferrule, ETFE, BlackLine, M6, 3 mm capillary
51.8.1.06030-02	Nut, POM, BlackLine, M6, 3 mm capillary
51.1.1.06030-01	Nut, PEEK, BlackLine, M6, 3 mm capillary



P/N	Description (2 pcs/pkg)
51.8.2106.10-00	Union, POM, BlackLine, M6, bore 1.0 mm, body only
51.8.2106.10-01	Union, POM, BlackLine, M6, bore 1.0 mm, complete for 1/16" capillary
51.8.2106.10-02	Union, POM, BlackLine, M6, bore 1.0 mm, complete for 3 mm capillary
51.8.2106.10-03	Union, POM, BlackLine, M6, bore 1.0 mm, complete for 2 mm capillary
51.8.3106.10-00	Tee, POM, BlackLine, M6, bore 1.0 mm, body only
51.8.3106.10-01	Tee, POM, BlackLine, M6, bore 1.0 mm, complete for 1/16" capillary
51.8.3106.10-02	Tee, POM, BlackLine, M6, bore 1.0 mm, complete for 3 mm capillary
51.8.3106.10-03	Tee, POM, BlackLine, M6, bore 1.0 mm, complete for 2 mm capillary



# BLACKLINE PEEK FITTINGS

## FITTINGS AND CONNECTORS 1/4-28

### INFO:

#### LOW-PRESSURE, 1/4-28 THREAD

P/N	Description (2 pcs/pkg)
51.1.21125.10-00	Union, PEEK, reducing, BlackLine, 10-32 to 1/4-28, bore 1.0 mm, body only
51.1.31125.10-01	Union, PEEK, reducing, BlackLine, 10-32 to 1/4-28, bore 1.0 mm, complete
51.1.31125.10-00	Tee, PEEK, reducing, BlackLine, 2 x 10-32 to 1/4-28, bore 1.0 mm, body only
51.1.21125.10-01	Tee, PEEK, reducing, BlackLine, 2 x 10-32 to 1/4-28, bore 1.0 mm, complete

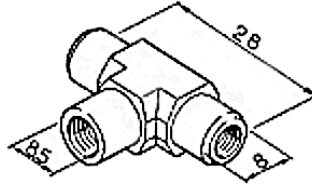
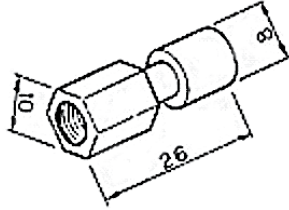

#### BLACK LINE FITTINGS AND CONNECTORS, LOW-PRESSURE, 1/4-28 THREAD

P/N	Description (10 pcs/pkg)
51.2.1.04020-03	Ferrule, ETFE, BlackLine, 1/4-28, 2 mm capillary
51.2.1.04030-03	Ferrule, ETFE, BlackLine, 1/4-28, 3 mm capillary
51.2.1.04062-03	Ferrule, ETFE, BlackLine, 1/4-28, 1/16" capillary
51.2.1.04125-03	Ferrule, ETFE, BlackLine, 1/4-28, 1/8" capillary
51.1.1.04030-01	Nut, PEEK, BlackLine, 1/4-28, 3 mm and 1/8" capillary
51.1.1.04062-01	Nut, PEEK, BlackLine, 1/4-28, 1/16" capillary
51.1.1.04020-01	Nut, PEEK, BlackLine, 1/4-28, 2 mm capillary
51.8.1.04030-02	Nut, POM, BlackLine, 1/4-28, 3 mm and 1/8" capillary
51.8.1.04062-02	Nut, POM, BlackLine, 1/4-28, 1/16" capillary
51.8.1.04020-02	Nut, POM, BlackLine, 1/4-28, 2 mm capillary

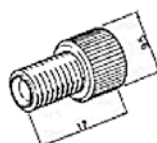
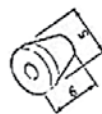
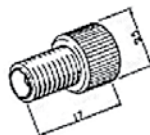



# BLACKLINE PEEK FITTINGS

## REDUCING CONNECTORS

INFO:

P/N	Description (2 pcs/pkg)
51.1.21125.10-00	Union, PEEK, BlackLine, 1/4-28, bore 1.0 mm, body only
51.1.21125.10-01	Union, PEEK, BlackLine, 1/4-28, bore 1.0 mm, complete for 1/16" capillary
51.1.21125.10-02	Union, PEEK, BlackLine, 1/4-28, bore 1.0 mm, complete for 1/8" capillary
51.1.31125.10-00	Tee, PEEK, BlackLine, 1/4-28, bore 1.0 mm, body only
51.1.31125.10-01	Tee, PEEK, BlackLine, 1/4-28, bore 1.0 mm, complete for 1/16" capillary
51.1.31125.10-02	Tee, PEEK, BlackLine, 1/4-28, bore 1.0 mm, complete for 1/8" capillary
51.1.41125.10-00	Cross, PEEK, BlackLine, 1/4-28, bore 1.0 mm, body only
51.1.41125.10-01	Cross, PEEK, BlackLine, 1/4-28, bore 1.0 mm, complete for 1/16" capillary
51.1.41125.10-02	Cross, PEEK, BlackLine, 1/4-28, bore 1.0 mm, complete for 1/8" capillary

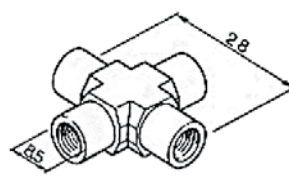
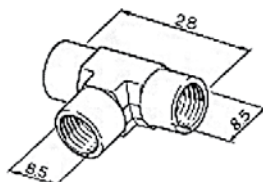
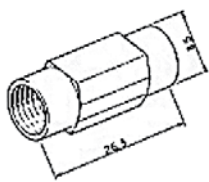

# FITTINGS

## HIGH PRESSURE FITTINGS PEEK

### INFO:

All of Applied Research PEEK fittings and accessories are manufactured from virgin VICTREX PEEK. We take a pride in our work and make sure that we only use the finest materials available. We decided to cut down on the range of fittings and ferrules for our standard PEEK fitting line, but offer you instead a reliable product with our BlackLine fitting series.

### ONE-PIECE FITTINGS

#### Fingertight

52.1.1.062.100	Fitting, PEEK, one-piece fingertight, 10-32
52.1.1.062.110	Fitting, PEEK, one-piece fingertight long, 10-32
52.1.1.062.240	Fitting, PEEK, one-piece fingertight narrow hex-head, 10-32
52.1.1.062.190	Fitting, PEEK, one-piece fingertight short head, 10-32

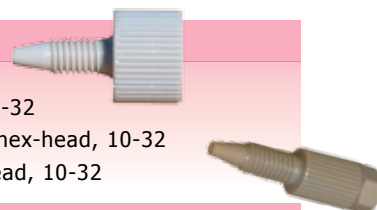

#### Hex-Head

52.1.1.062.210	Fitting, PEEK, one-piece hex-head long, 10-32
52.1.1.062.220	Fitting, PEEK, one-piece hex-head short, 10-32



#### Combi-Head

52.1.1.062.500	Fitting, PEEK, one-piece natural, combi-head 10-32
52.1.1.062.501	Fitting, PEEK, one-piece red, combi-head 10-32
52.1.1.062.502	Fitting, PEEK, one-piece yellow, combi-head 10-32
52.1.1.062.503	Fitting, PEEK, one-piece blue, combi-head 10-32
52.1.1.062.505	Fitting, PEEK, one-piece green, combi-head 10-32
52.1.1.062.507	Fitting, PEEK, one-piece black, combi-head 10-32

### TWO-PIECE NUT/FERRULE COMBINATIONS

#### Fingertight

58.1.1.062.100	Nut, PEEK, fingertight for double ferrule, 1/16"
58.1.1.062.160	Nut, PEEK, fingertight for single ferrule, 1/16"

#### Hex-Head

58.1.1.062.210	Nut, PEEK, hex-head long for double ferrule, 10-32
58.1.1.062.220	Nut, PEEK, hex-head short for double ferrule, 10-32



#### Ferrules

59.1.0.062.20	Ferrule, PEEK, double, 1/16"
59.1.0.062.00	Ferrule, PEEK, single, 1/16"
59.1.0.062.10	Ferrule, PEEK, solid cone, 10-32
59.1.0.062.30	Ferrule, PEEK, special, 1/16" (for use with our PEEK sample loops)

### CONNECTORS

#### Union

55.1.20062.03-00	Union, PEEK, 10-32, bore 0.3 mm, body only
55.1.20062.03-01	Union, PEEK, 10-32, bore 0.3 mm, complete



#### Tee

55.1.30062.03-00	Tee, PEEK, 10-32, bore 0.3 mm, body only
55.1.30062.03-01	Tee, PEEK, 10-32, bore 0.3 mm, complete

#### Mixing Tee

55.1.33362.03-01	Tee, PEEK, mixing, complete, 10-32
------------------	------------------------------------



#### Cross

55.1.40062.03-00	Cross, PEEK, 10-32, bore 0.3 mm, body only
55.1.40062.03-01	Cross, PEEK, 10-32, bore 0.3 mm, complete

# FITTINGS

## HIGH PRESSURE FITTINGS SS

### INFO:

All of [Applied Research SS](#) fittings and accessories are manufactured from SS316L (DIN 1.4435). We take a pride in our work and make sure that we only use the finest materials available.

### TWO-PIECE NUT/FERRULE COMBINATIONS

#### Fingertight

- 58.6.1.062.100 Nut, SS, fingertight for double ferrule, 10-32
- 58.6.1.062.140 Nut, SS, fingertight, narrow, 10-32

#### Hex-Head

- 58.6.1.062.210 Nut, SS, medium, 10-32
- 58.6.1.062.220 Nut, SS, short, 10-32
- 58.6.1.062.230 Nut, SS, x-long, 10-32

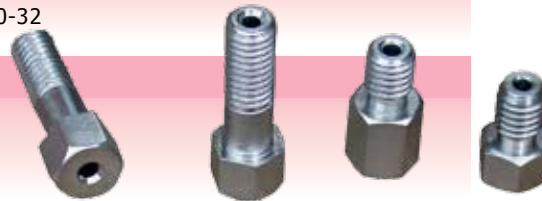

#### Ferrules

- 59.6.0.062.00 Ferrule, SS, single, 1/16"
- 59.6.0.062.20 Ferrule, SS, single, 1/16", 2-step Rheodyne
- 59.1.0.062.20 Ferrule, PEEK, double, 1/16"
- 59.1.0.062.00 Ferrule, PEEK, single, 1/16"



### CONNECTORS

#### Union

- 55.6.2.0062.03-00 Union, SS, 10-32, bore 0.25 mm, body only
- 55.6.2.0062.03-01 Union, SS, 10-32, bore 0.25 mm, complete
- 55.6.2.0062.05-00 Union, SS, 10-32, bore 0.5 mm, body only
- 55.6.2.0062.05-01 Union, SS, 10-32, bore 0.5 mm, complete
- 55.6.2.0062.08-00 Union, SS, 10-32, bore 0.8 mm, body only
- 55.6.2.0062.08-01 Union, SS, 10-32, bore 0.8 mm, complete



#### Tee

- 55.6.3.0062.03-00 Tee, SS, 10-32, bore 0.25 mm, body only
- 55.6.3.0062.03-01 Tee, SS, 10-32, bore 0.25 mm, complete

#### Cross

- 55.6.4.0062.03-00 Cross, SS, 10-32, bore 0.25 mm, body only
- 55.6.4.0062.03-01 Cross, SS, 10-32, bore 0.25 mm, complete

# FITTINGS

## LOW AND MEDIUM PRESSURE FITTINGS

### INFO:

All of **Applied Research** fittings and accessories are manufactured from the finest materials available. We decided to cut down on the range of fittings and ferrules for our standard fitting line,, but offer you instead a reliable product with our BlackLine fitting series.

#### FLANGED FITTING SERIES

##### For 1/16" Tubing

57.9.2.062.40	Nut, PP, flanged white 1/16", 1/4-28
57.9.2.062.41	Nut, PP, flanged red 1/16", 1/4-28
57.9.2.062.42	Nut, PP, flanged yellow 1/16", 1/4-28
57.9.2.062.43	Nut, PP, flanged blue 1/16", 1/4-28
57.9.2.062.45	Nut, PP, flanged green 1/16", 1/4-28
57.9.2.062.47	Nut, PP, flanged black 1/16", 1/4-28
57.9.2.062.90	Washer, PP, for flanged nut 1/16"



##### For 1/8" Tubing

57.9.2.125.40	Nut, PP, flanged white 1/8", 1/4-28
57.9.2.125.41	Nut, PP, flanged red 1/8", 1/4-28
57.9.2.125.42	Nut, PP, flanged yellow 1/8", 1/4-28
57.9.2.125.43	Nut, PP, flanged blue 1/8", 1/4-28
57.9.2.125.45	Nut, PP, flanged green 1/8", 1/4-28
57.9.2.125.47	Nut, PP, flanged black 1/8", 1/4-28
57.9.2.125.90	Washer, PP, for flanged nut 1/8"

Flangy, the **Applied Research** tool for cold flanging of polymer tubing, provides an easy and smooth way to make flanging easy. As the flange is made mechanical, rather than by heat, the flange itself will be more long-lasting and stable. The kit contains a complete set of flanging tool and flanging discs. The Combi kit will include even a selection of PTFE tubing and flanged nuts and rings.

#### FLANGING TOOL

##### Flanging Tool Kits

70.0100.001	Flangy, kit in plastic case (flanging tool with 4 flanging discs)
70.0100.002	Flangy, combi kit in plastic case (flanging tool with 4 flanging discs; PTFE tubing, selection of flanged nuts and PP rings).

##### Flanging Tool Spare Parts

70.0100.105	Flangy, flanging disc with 0.5 mm SS pin for PEEK tubing
70.0100.108	Flangy, flanging disc with 0.8 mm polymer pin
70.0100.308	Flangy, flanging disc with 0.8 mm Titanium pin
70.0100.110	Flangy, flanging disc with 1.0 mm polymer pin
70.0100.113	Flangy, flanging disc with 1.3 mm polymer pin
70.0100.313	Flangy, flanging disc with 1.3 mm Titanium pin
70.0100.115	Flangy, flanging disc with 1.5 mm polymer pin
70.0101.010	Flangy, clamp pair. Spare part for 70.0100.00x

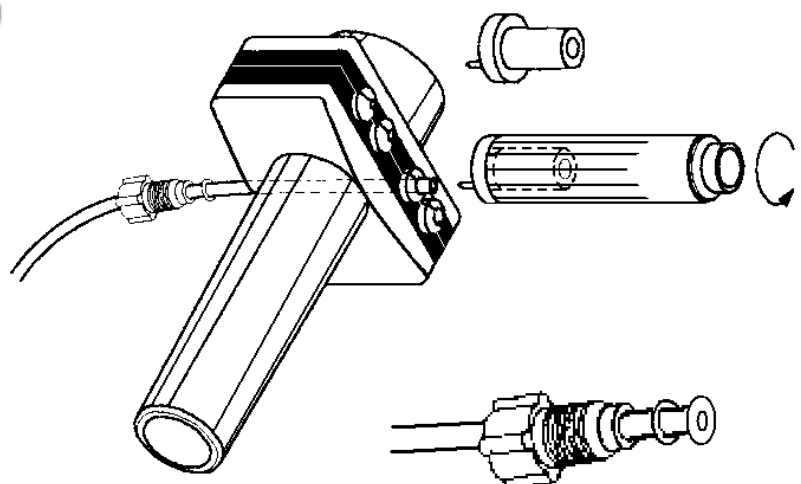



# FITTINGS

## LOW AND MEDIUM PRESSURE FITTINGS

### INFO:

All of [Applied Research](#) PEEK fittings and accessories are manufactured from virgin VICTREX PEEK. We take a pride in our work and make sure that we use only the finest materials available.

#### FLANGE-FREE FITTING SERIES

##### PEEK Fitting for 1/16" Tubing

- 58.1.2.062.40 Nut, PEEK, flangefree natural 1/16", 1/4-28
- 58.1.2.062.41 Nut, PEEK, flangefree red 1/16", 1/4-28
- 58.1.2.062.42 Nut, PEEK, flangefree yellow 1/16", 1/4-28
- 58.1.2.062.43 Nut, PEEK, flangefree blue 1/16", 1/4-28
- 58.1.2.062.45 Nut, PEEK, flangefree green 1/16", 1/4-28
- 58.1.2.062.47 Nut, PEEK, flangefree black 1/16", 1/4-28
- 59.2.1.062.00 Ferrule, PTFE, single, 1/16"
- 59.5.1.062.00 Ferrule, ETFE, single, 1/16"
- 59.10.1.062.00 Ferrule, KEL-F, single, 1/16"

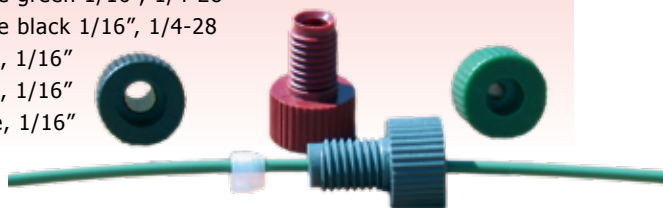

##### PEEK Fitting for 1/8" Tubing

- 58.1.2.125.40 Nut, PEEK, flangefree natural 1/8", 1/4-28
- 58.1.2.125.41 Nut, PEEK, flangefree red 1/8", 1/4-28
- 58.1.2.125.42 Nut, PEEK, flangefree yellow 1/8", 1/4-28
- 58.1.2.125.43 Nut, PEEK, flangefree blue 1/8", 1/4-28
- 58.1.2.125.45 Nut, PEEK, flangefree green 1/8", 1/4-28
- 58.1.2.125.47 Nut, PEEK, flangefree black 1/8", 1/4-28
- 59.1.1.125.00 Ferrule, PEEK, single, 1/8"
- 59.5.1.125.00 Ferrule, ETFE, single, 1/8"

##### Delrin Fitting for 1/16" Tubing

- 58.8.2.062.41 Nut, Delrin, flangeless red 1/16", 1/4-28
- 58.8.2.062.42 Nut, Delrin, flangeless yellow 1/16", 1/4-28
- 58.8.2.062.43 Nut, Delrin, flangeless blue 1/16", 1/4-28
- 58.8.2.062.45 Nut, Delrin, flangeless green 1/16", 1/4-28
- 58.8.2.062.47 Nut, Delrin, flangeless black 1/16", 1/4-28
- 58.8.2.062.48 Nut, Delrin, flangeless white 1/16", 1/4-28
- 59.2.1.062.00 Ferrule, PTFE, single, 1/16"
- 59.5.1.062.00 Ferrule, ETFE, single, 1/16"



##### Delrin Fitting for 1/8" Tubing

- 58.8.2.125.41 Nut, Delrin, flangeless 1/8", red, 1/4-28
- 58.8.2.125.42 Nut, Delrin, flangeless 1/8", yellow, 1/4-28
- 58.8.2.125.43 Nut, Delrin, flangeless 1/8", blue, 1/4-28
- 58.8.2.125.45 Nut, Delrin, flangeless 1/8", green, 1/4-28
- 58.8.2.125.47 Nut, Delrin, flangeless 1/8", black, 1/4-28
- 58.8.2.125.48 Nut, Delrin, flangeless 1/8", white, 1/4-28
- 59.5.1.125.00 Ferrule, ETFE, single, 1/8"

# FITTINGS

## LOW AND MEDIUM PRESSURE FITTINGS

### INFO:

All of [Applied Research](#) PEEK fittings and accessories are manufactured from virgin VICTREX PEEK. We take a pride in our work and make sure that we only use the finest materials available. We decided to cut down on the range of fittings and ferrules for our standard PEEK fitting line, but offer you instead a reliable product with our BlackLine fitting series.

### ACCESSORIES FOR LOW AND MEDIUM PRESSURE FITTING SERIES

#### Ferrules

59.2.1.062.00	Ferrule, PTFE, single, 1/16"
59.5.1.062.00	Ferrule, ETFE, single, 1/16"
59.10.1.062.00	Ferrule, KEL-F, single, 1/16"
59.1.1.125.00	Ferrule, PEEK, single, 1/8"
59.5.1.125.00	Ferrule, ETFE, single, 1/8"
59.10.1.125.70	Ferrule, KEL-F, single, for No-Ox fitting
59.2.2.062.00	Ferrule, PTFE, reducing, 1/8" - 1/16"

#### Unions

55.1.21125.08-00	Union, PEEK, 1/4-28, bore 0.8 mm, body only
55.1.21125.08-01	Union, PEEK, 1/4-28, bore 0.8 mm, complete
55.1.21125.15-00	Union, PEEK, 1/4-28, bore 1.5 mm, body only
55.1.21125.15-01	Union, PEEK, 1/4-28, bore 1.5 mm, complete
55.8.20125.00-00	Union, Nylon, 1/4-28, body only

#### Tees

55.1.31125.08-00	Tee, PEEK, 1/4-28, bore 0.8 mm, body only
55.1.31125.08-01	Tee, PEEK, 1/4-28, bore 0.8 mm, complete
55.1.31125.15-00	Tee, PEEK, 1/4-28, bore 1.5 mm, body only
55.1.31125.15-01	Tee, PEEK, 1/4-28, bore 1.5 mm, complete

#### Cross

55.1.41125.08-00	Cross, PEEK, 1/4-28, bore 0.8 mm, body only
55.1.41125.08-01	Cross, PEEK, 1/4-28, bore 0.8 mm, complete
55.1.41125.15-00	Cross, PEEK, 1/4-28, bore 1.5 mm, body only
55.1.41125.15-01	Cross, PEEK, 1/4-28, bore 1.5 mm, complete

#### Plug

53.1.200400-00	Plug, PEEK, 10-32
53.1.200500-00	Plug, PEEK, 1/4-28
53.1.200600-00	Plug, PEEK, M6



# FITTINGS

## LOW AND MEDIUM PRESSURE ADAPTER

### INFO:

This line of adapters from [Applied Research](#) will serve most needs of chromatographers. The use for the PEEK adapters is both for the high- and low pressure range. Polypropylene adapters should be used only with low pressure applications.

#### PEEK ADAPTER

53.1.0401.13	Adapter, PEEK, 10-32 female to female Luer, 1.3 mm bore
53.1.0405.03	Adapter, PEEK, 10-32 female to 1/4-28 female, 0.25 mm bore
53.1.0451.13	Adapter, PEEK, 10-32 female to male Luer, 1.3 mm bore
53.1.0455.04	Adapter, PEEK, 10-32 female to 1/4-28 male, 0.4 mm bore
53.1.0456.04	Adapter, PEEK, 10-32 female to M6 male, 0.4 mm bore
53.1.0457.04	Adapter, PEEK, 10-32 female to Waters male, 0.4 mm bore
53.1.0501.13	Adapter, PEEK, 1/4-28 female to female Luer, 1.3 mm bore
53.1.0551.13	Adapter, PEEK, 1/4-28 female to male Luer, 1.3 mm bore
53.1.0554.04	Adapter, PEEK, 1/4-28 female to 10-32 male, 0.4 mm bore
53.1.0556.04	Adapter, PEEK, 1/4-28 female to M6 male, 0.4 mm bore
53.1.0557.04	Adapter, PEEK, 1/4-28 female to Waters male, 0.4 mm bore
53.1.0601.13	Adapter, PEEK, M6 female to female Luer, 1.3 mm bore
53.1.0651.13	Adapter, PEEK, M6 female to male Luer, 1.3 mm bore
53.1.0654.04	Adapter, PEEK, M6 female to 10-32 male, 0.4 mm bore
53.1.0655.04	Adapter, PEEK, M6 female to 1/4-28 male, 0.4 mm bore
53.1.0657.04	Adapter, PEEK, M6 female to Waters male, 0.4 mm bore
53.1.0754.04	Adapter, PEEK, Waters female to 10-32 male, 0.4 mm bore
53.1.0755.04	Adapter, PEEK, Waters female to 1/4-28 male, 0.4 mm bore
53.1.0756.04	Adapter, PEEK, Waters female to M6 male, 0.4 mm bore

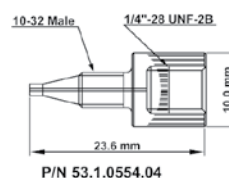
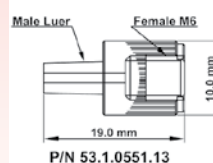
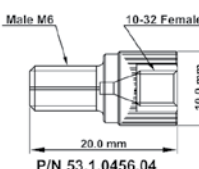
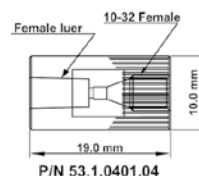

#### POLYPROPYLEN ADAPTER

53.9.200101	Adapter, PP, female to female Luer
53.9.200111	Adapter, PP, female Luer to 1/16" barbed
53.9.200112	Adapter, PP, female Luer to 3/32" barbed
53.9.200113	Adapter, PP, female Luer to 1/8" barbed
53.9.200124	Adapter, PP, female Luer to 10-32 male
53.9.200125	Adapter, PP, female Luer to 1/4-28 female
53.9.200211	Adapter, PP, male Luer to 1/16" barbed
53.9.200212	Adapter, PP, male Luer to 3/32" barbed
53.9.200213	Adapter, PP, male Luer to 1/8" barbed
53.9.200224	Adapter, PP, male Luer to 10-32 male
53.9.200225	Adapter, PP, male Luer to 1/4-28 female
53.9.201111	Adapter, PP, barbed connector 1/16"
53.9.201112	Adapter, PP, barbed connector 3/32"
53.9.201113	Adapter, PP, barbed connector 1/8"
53.9.201211	Adapter, PP, barbed connector 3/32" to 1/16"
53.9.201311	Adapter, PP, barbed connector 1/16" to 1/8"
53.9.201312	Adapter, PP, barbed connector 3/32" to 1/8"
53.9.309411	Tee, PP, barbed for 1/16" tubing
53.9.309412	Tee, PP, barbed for 3/32" tubing
53.9.309413	Tee, PP, barbed for 1/8" tubing
53.9.309516	Tee, PP, barbed 2 x 1/16" to 3/32" tubing
53.9.309517	Tee, PP, barbed 2 x 1/16" to 1/8" tubing
53.9.309518	Tee, PP, barbed 2 x 2/32" to 1/16" tubing
53.9.309911	Tee, PP, Y-formed barbed 1/16" tubing
53.9.309912	Tee, PP, Y-formed barbed 3/32" tubing
53.9.309913	Tee, PP, Y-formed barbed 1/8" tubing
53.9.200350	Plug, PP, male Luer

# FILTER AND FRITS

## BIOCOMPATIBLE FRITS

### INFO:

PAT (PEEK Alloyed with Teflon) is a polymer alloy developed for use as bio-compatible filter material. PAT consists of PEEK material, which is sintered using a small amount of PTFE Teflon material. Thus, combining the highest possible mechanical strength with chemical inertness.

Titanium filter discs combine mechanical strength of a metal filter disc with chemical inertness.

Combine the advantages of [Applied Research](#) PAT biocompatible filter disc and the sealing PEEK ring, resulting in lower filter volume and bandspreading.

Combine the advantage of [Applied Research](#) Titanium biocompatible filter disc with the advantage of the sealing PEEK ring providing lower filter volume and bandspreading.

#### PAT FILTER DISCS

P/N	Diameter in		Thickness in		Pore Size in
	Inch	mm	Inch	mm	µm
16.062.32.020	0.062	1.57	0.032	0.81	2
16.062.32.050	0.062	1.57	0.032	0.81	5
16.125.32.020	0.125	3.18	0.032	0.81	2
16.125.32.050	0.125	3.18	0.032	0.81	5
16.188.32.100	0.188	4.78	0.032	0.81	10
16.188.62.020	0.188	4.78	0.062	1.57	2
16.188.62.050	0.188	4.78	0.062	1.57	5
16.500.32.100	0.500	12.70	0.032	0.81	10
16.500.32.050	0.500	12.70	0.032	0.81	5
16.750.62.100	0.750	19.05	0.062	1.57	10

#### TITANIUM FILTER DISCS

P/N	Diameter in		Thickness in		Pore Size in
	Inch	mm	Inch	mm	µm
12.181.62.005-00	0.181	4.60	0.062	1.57	0.5
12.181.62.020-00	0.181	4.60	0.062	1.57	2
12.250.39.005-00	0.250	6.35	0.039	0.99	0.5
12.250.39.020-00	0.250	6.35	0.039	0.99	2
12.375.62.050-00	0.375	9.53	0.062	1.57	5

#### PAT FILTER DISCS PEEK ENCASED

P/N	Ring Diameter in		Frit Diameter in		Thickness in		Pore Size in
	Inch	mm	Inch	mm	Inch	mm	µm
161.200.102.050	0.200	5.08	0.102	2.59	0.062	1.57	5
161.250.188.020	0.250	6.35	0.188	4.78	0.062	1.57	2
161.250.188.050	0.250	6.35	0.188	4.78	0.062	1.57	5
161.250.188.100	0.250	6.35	0.188	4.78	0.062	1.57	10
161.375.312.050	0.375	9.53	0.312	7.92	0.062	1.57	5

#### TITANIUM FILTER DISCS PEEK ENCASED

P/N	Ring Diameter in		Frit Diameter in		Thickness in		Pore Size in
	Inch	mm	Inch	mm	Inch	mm	µm
121.250.125-005	0.250	6.35	0.125	3.18	0.062	1.57	0.5
121.250.125-020	0.250	6.35	0.125	3.18	0.062	1.57	2
121.250.153-005	0.250	6.35	0.153	3.89	0.062	1.57	0.5
121.250.153-020	0.250	6.35	0.153	3.89	0.062	1.57	2
121.250.181-005	0.250	6.35	0.181	4.60	0.062	1.57	0.5
121.250.181-020	0.250	6.35	0.181	4.60	0.062	1.57	2

**Please Note:** Other dimensions are available on request.



# FILTER AND FRITS

## METAL FRITS

### INFO:

All Applied Research metal filter discs are manufactured to highest possible precision with the finest raw materials available. Material and inspection reports can be received upon request.

### SS FILTER DISCS

P/N	Diameter in		Thickness in		Pore Size in
	Inch	mm	Inch	mm	µm
11.062.39.005-00	0.062	1.57	0.039	0.99	0.5
11.062.39.020-00	0.062	1.57	0.039	0.99	2
11.062.39.050-00	0.062	1.57	0.039	0.99	5
11.062.62.005-00	0.062	1.57	0.062	1.57	0.5
11.062.62.020-00	0.062	1.57	0.062	1.57	2
11.062.62.050-00	0.062	1.57	0.062	1.57	5
11.062.62.100-00	0.062	1.57	0.062	1.57	10
11.082.62.020-00	0.082	2.08	0.062	1.57	2
11.093.62.005-00	0.093	2.36	0.062	1.57	0.5
11.093.62.020-00	0.093	2.36	0.062	1.57	2
11.093.62.050-00	0.093	2.36	0.062	1.57	5
11.093.62.100-00	0.093	2.36	0.062	1.57	10
11.125.39.005-00	0.125	3.18	0.039	0.99	0.5
11.125.39.020-00	0.125	3.18	0.039	0.99	2
11.125.39.050-00	0.125	3.18	0.039	0.99	5
11.125.39.100-00	0.125	3.18	0.039	0.99	10
11.125.62.005-00	0.125	3.18	0.062	1.57	0.5
11.125.62.020-00	0.125	3.18	0.062	1.57	2
11.125.62.050-00	0.125	3.18	0.062	1.57	5
11.125.62.100-00	0.125	3.18	0.062	1.57	10
11.156.39.020-00	0.156	3.96	0.039	0.99	2
11.156.62.005-00	0.156	3.96	0.062	1.57	0.5
11.156.62.020-00	0.156	3.96	0.062	1.57	2
11.181.62.005-00	0.181	4.6	0.062	1.57	0.5
11.181.62.020-00	0.181	4.6	0.062	1.57	2
11.188.62.005-00	0.188	4.78	0.062	1.57	0.5
11.188.62.020-00	0.188	4.78	0.062	1.57	2
11.188.62.050-00	0.188	4.78	0.062	1.57	5
11.188.62.100-00	0.188	4.78	0.062	1.57	10
11.197.39.005-00	0.197	5.00	0.039	0.99	0.5
11.205.59.020-00	0.205	5.21	0.059	1.5	2
11.250.39.001-00	0.25	6.35	0.039	0.99	0.1
11.250.39.005-00	0.25	6.35	0.039	0.99	0.5
11.250.39.020-00	0.25	6.35	0.039	0.99	2
11.250.39.050-00	0.25	6.35	0.039	0.99	5
11.250.39.100-00	0.25	6.35	0.039	0.99	10
11.250.62.005-00	0.25	6.35	0.062	1.57	0.5
11.250.62.020-00	0.25	6.35	0.062	1.57	2
11.250.62.050-00	0.25	6.35	0.062	1.57	5
11.250.62.100-00	0.25	6.35	0.062	1.57	10
11.375.39.005-00	0.375	9.53	0.039	0.99	0.5
11.375.39.020-00	0.375	9.53	0.039	0.99	2
11.375.62.020-00	0.375	9.53	0.062	1.57	2
11.500.62.005-00	0.5	12.7	0.062	1.57	0.5
11.500.62.020-00	0.5	12.7	0.062	1.57	2
11.500.62.050-00	0.5	12.7	0.062	1.57	5
11.750.62.020-00	0.75	19.05	0.062	1.57	2
11.750.62.100-00	0.75	19.05	0.062	1.57	10
11.1.62.005-00	1	25.4	0.062	1.57	0.5
11.1.62.020-00	1	25.4	0.062	1.57	2
11.1.62.050-00	1	25.4	0.062	1.57	5
11.1.62.100-00	1	25.4	0.062	1.57	10



**Please Note:** Other dimensions are available on request. Filter discs with the ending -00 are manufactured with a chamfer. Filter discs with the ending -01 do not have a chamfer, but a sharp edge.

# FILTER AND FRITS

## METAL FRITS

### INFO:

Combine the advantage of [Applied Research](#) SS filter disc with the advantage of the sealing PEEK ring providing lower filter volume and bandspreading.

#### SS FILTER DISCS PEEK ENCASED

P/N	Ring Diameter in		Frit diameter in		Thickness in		Pore Size in $\mu\text{m}$
	Inch	mm	Inch	mm	Inch	mm	
111.250.078-005	0.250	6.35	0.078	2.0	0.062	1.58	0.5
111.250.078-020	0.250	6.35	0.078	2.0	0.062	1.58	2
111.250.125-005	0.250	6.35	0.125	3.2	0.062	1.58	0.5
111.250.125-020	0.250	6.35	0.125	3.2	0.062	1.58	2
111.250.153-005	0.250	6.35	0.153	3.9	0.062	1.58	0.5
111.250.153-020	0.250	6.35	0.153	3.9	0.062	1.58	2
111.250.181-005	0.250	6.35	0.181	4.6	0.062	1.58	0.5
111.250.181-020	0.250	6.35	0.181	4.6	0.062	1.58	2
112.250.181-005	0.250	6.35	0.181	4.6	0.032	0.81	0.5
112.250.181-020	0.250	6.35	0.181	4.6	0.032	0.81	2
113.118.038-005	0.118	2.997	0.038	1.0	0.028	0.71	0.5
113.118.038-020	0.118	2.997	0.038	1.0	0.028	0.71	2
113.118.038-050	0.118	2.997	0.038	1.0	0.028	0.71	5
113.118.077-005	0.118	2.997	0.077	1.96	0.028	0.71	0.5
113.118.077-020	0.118	2.997	0.077	1.96	0.028	0.71	2
113.118.077-050	0.118	2.997	0.077	1.96	0.028	0.71	5
113.260.173.050	0.260	6.604	0.173	4.4	Hibar-Frit		5
118.260.173.050	0.260	6.604	0.173	4.4	Hibar-Frit		5

Combine the advantage of [Applied Research](#) SS filter disc with the advantage of the sealing KEL-F ring providing lower filter volume and bandspreading.

#### SS FILTER DISCS KEL-F ENCASED

P/N	Ring Diameter in		Frit Diameter in		Thickness in		Pore Size in $\mu\text{m}$
	Inch	mm	Inch	mm	Inch	mm	
115.250.125.005	0.250	6.350	0.125	3.175	0.032	0.813	0.5
115.250.153.005	0.250	6.350	0.153	3.886	0.032	0.813	0.5
115.250.153.020	0.250	6.350	0.153	3.886	0.032	0.813	2

[Applied Research](#) Hastelloy discs are an alternative to stainless steel for demanding applications requiring greater inertness. Even in certain biocompatible applications our Hastelloy C filters can be used. All [Applied Research](#) metal filter discs are manufactured to highest possible precision with the finest raw materials available. Material and inspection reports can be received upon special request.

#### HASTELLOY FILTER DISCS

P/N	Diameter in		Thickness in		Pore Size in $\mu\text{m}$
	Inch	mm	Inch	mm	
13.205.39.005-00	0.205	5.207	0.039	0.991	0.5
13.205.39.005-01	0.205	5.207	0.039	0.991	0.5
13.205.39.020-00	0.205	5.207	0.039	0.991	2.0
13.250.39.020-00	0.250	6.350	0.039	0.991	2.0



**Please Note:** Filter discs with the ending -00 are manufactured with a chamfer. Filter discs with the ending -01 do not have a chamfer, but a sharp edge.

# FILTER AND FRITS

## SOLVENT FILTERS SS

### INFO:

All Applied Research SS solvent filters are manufactured from the finest raw materials available. We have developed the total steel filter in order to avoid contamination of your valuable solvent. We offer our solvent filter in three different version: with a 1/16" diameter stem, with the 1/8" diameter stem and a new type of connection with the internal thread. Make the secure fit of your solvent line; you have only to screw your filter onto the tube and it will not slip off.

#### 1/16" OD STEM

P/N	Diameter in		Length in		Pore Size in $\mu\text{m}$
	Inch	mm	Inch	mm	
221.375.63-02	0.375	9.53	0.63	16.00	2
221.375.63-05	0.375	9.53	0.63	16.00	5
221.375.1-02	0.375	9.53	1.0	25.40	2
221.375.1-05	0.375	9.53	1.0	25.40	5
221.375.1-10	0.375	9.53	1.0	25.40	10
221.500.1-02	0.50	12.70	1.0	25.40	2
221.500.1-05	0.50	12.70	1.0	25.40	5
221.500.1-10	0.50	12.70	1.0	25.40	10

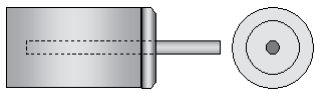

L = 0.63" D = 0.375"

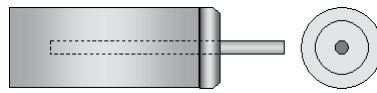

L = 1.0" D = 0.375"

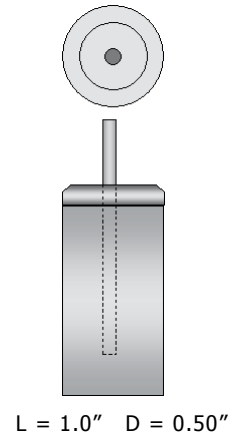

L = 1.0" D = 0.50"

#### 1/8" OD STEM

P/N	Diameter in		Length in		Pore Size in $\mu\text{m}$
	Inch	mm	Inch	mm	
222.500.1-02	0.50	12.70	1.0	25.40	2
222.500.1-05	0.50	12.70	1.0	25.40	5
222.500.1-10	0.50	12.70	1.0	25.40	10
222.680.1-02	0.68	17.27	1.0	25.40	2
222.680.1-05	0.68	17.27	1.0	25.40	5
222.680.1-10	0.68	17.27	1.0	25.40	10

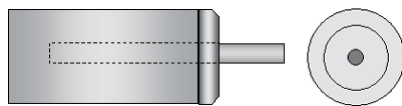

L = 1.0" D = 0.50"

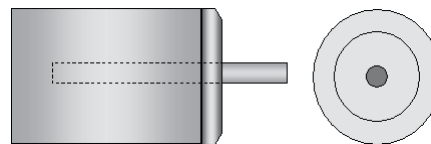

L = 1.0" D = 0.68"

#### 5-40 INTERNAL THREAD FOR 1/8" TUBING

P/N	Diameter in		Length in		Pore Size in $\mu\text{m}$
	Inch	mm	Inch	mm	
225.375.63-02	0.375	9.53	0.63	16.00	2
225.375.63-05	0.375	9.53	0.63	16.00	5
225.375.63-10	0.375	9.53	0.63	16.00	10
225.375.1-02	0.375	9.53	1.0	25.40	2
225.375.1-05	0.375	9.53	1.0	25.40	5
225.375.1-10	0.375	9.53	1.0	25.40	10
225.500.1-02	0.50	12.70	1.0	25.40	2
225.500.1-05	0.50	12.70	1.0	25.40	5
225.500.1-10	0.50	12.70	1.0	25.40	10
225.680.1-02	0.68	17.27	1.0	25.40	2
225.680.1-05	0.68	17.27	1.0	25.40	5
225.680.1-10	0.68	17.27	1.0	25.40	10

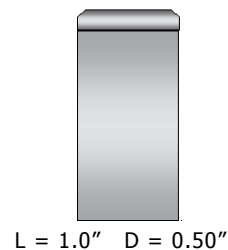
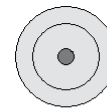

L = 1.0" D = 0.50"



L = 0.63" D = 0.375"



L = 1.0" D = 0.375"

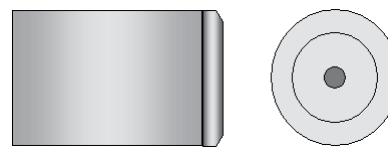

L = 1.0" D = 0.68"

# FILTER AND FRITS

## SOLVENT- AND INLINE-FILTER

### INFO:

All Applied Research SS solvent-filters are manufactured to give you the best filter capacity in order to avoid contamination of your valuable column. We offer our solvent filters with three different connectors. For 1/16" and 1/8" tubing we use flange-free PEEK connectors with ETFE ferrules. The tripod connector allows you to slip the tubing over the adapter.

#### SS MOBILE PHASE FILTER

220.375.1-020.1	Filter, SS, mobile phase 2 µm, fittings for 1/16"
220.375.1-020.2	Filter, SS, mobile phase 2 µm, fittings for 1/8"
220.375.1-020.3	Filter, SS, mobile phase 2 µm, tripod tubing adapter
220.375.1-100.1	Filter, SS, mobile phase 10 µm, fittings for 1/16"
220.375.1-100.2	Filter, SS, mobile phase 10 µm, fittings for 1/8"
220.375.1-100.3	Filter, SS, mobile phase 10 µm, tripod tubing adapter
220.375.1-200.1	Filter, SS, mobile phase 20 µm, fittings for 1/16"
220.375.1-200.2	Filter, SS, mobile phase 20 µm, fittings for 1/8"
220.375.1-200.3	Filter, SS, mobile phase 20 µm, tripod tubing adapter

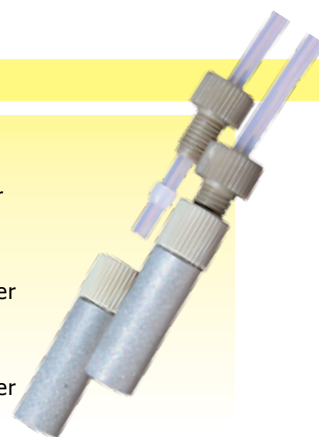

#### SS LAST-DROP AND LAST-DROP ECONOMY FILTER

250.750.6-020.1	Filter, SS, Last-Drop 2 µm, fittings for 1/16"
250.750.6-020.2	Filter, SS, Last-Drop 2 µm, fittings for 1/8"
250.750.6-020.3	Filter, SS, Last-Drop 2 µm, tripod tubing connector
250.750.6-050.1	Filter, SS, Last-Drop 5 µm, fittings for 1/16"
250.750.6-050.2	Filter, SS, Last-Drop 5 µm, fittings for 1/8"
250.750.6-050.3	Filter, SS, Last-Drop 5 µm, tripod tubing connector
250.750.6-100.1	Filter, SS, Last-Drop 10 µm, fittings for 1/16"
250.750.6-100.2	Filter, SS, Last-Drop 10 µm, fittings for 1/8"
250.750.6-100.3	Filter, SS, Last-Drop 10 µm, tripod tubing connector
240.750.6-020	Filter, SS, Last-Drop economy 2 µm, 25 mm diam.
240.750.6-050	Filter, SS, Last-Drop economy 5 µm, 25 mm diam.
240.750.6-100	Filter, SS, Last-Drop economy 10 µm, 25 mm diam.



#### BIOCOMPATIBLE SOLVENT FILTER

250.55.10.9.200.1	Solvent Filter, PE, biocompatible 20 µm, complete, fitting for 1/16"
250.55.10.9.200.2	Solvent Filter, PE, biocompatible 20 µm, complete, fitting for 1/8"
250.55.10.9.200.3	Solvent Filter, PE, biocompatible 20 µm, complete, tripod tubing connector
250.55.10.9.200.0	Solvent Filter, PE, biocompatible 20 µm, replacement filter

#### PTFE LAST-DROP AND LAST-DROP ECONOMY FILTER

250.750.1-025.1	Filter, PTFE, Last-Drop 2.5 µm, fittings for 1/16"
250.750.1-025.2	Filter, PTFE, Last-Drop 2.5 µm, fittings for 1/8"
250.750.1-025.3	Filter, PTFE, Last-Drop 2.5 µm, tripod tubing connector
250.750.1-050.1	Filter, PTFE, Last-Drop 5 µm, fittings for 1/16"
250.750.1-050.2	Filter, PTFE, Last-Drop 5 µm, fittings for 1/8"
250.750.1-050.3	Filter, PTFE, Last-Drop 5 µm, tripod tubing connector
250.750.1-100.1	Filter, PTFE, Last-Drop 10 µm, fittings for 1/16"
250.750.1-100.2	Filter, PTFE, Last-Drop 10 µm, fittings for 1/8"
250.750.1-100.3	Filter, PTFE, Last-Drop 10 µm, tripod tubing connector
240.750.1-025	Filter, PTFE, Last-Drop economy 2.5 µm, 25 mm diam.
240.750.1-050	Filter, PTFE, Last-Drop economy 5 µm, 25 mm diam.
240.750.1-100	Filter, PTFE, Last-Drop economy 10 µm, 25 mm diam.

#### SS INLINE-FILTER

227.6.0.077-020	InLine-filter, SS, complete, SS frit 0.077", PEEK encased, 2 µm pore size
227.6.0.077-050	InLine-filter, SS, complete, SS frit 0.077", PEEK encased, 5 µm pore size
227.6.0.125-020	InLine-filter, SS, complete, SS frit 0.125", PEEK encased, 2 µm pore size
227.6.0.125-050	InLine-filter, SS, complete, SS frit 0.125", PEEK encased, 5 µm pore size
227.6.0.188-020	InLine-filter, SS, complete, SS frit 0.188", PEEK encased, 2 µm pore size
227.6.0.188-050	InLine-filter, SS, complete, SS frit 0.188", PEEK encased, 5 µm pore size
227.6.2.000	InLine-filter, SS, female body only
227.6.1.000	InLine-filter, SS, male body only
227.6.0.000	InLine-filter, SS, complete body only

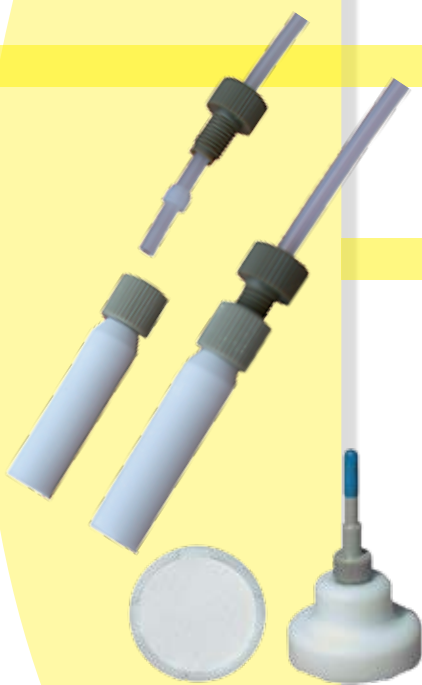



# FILTER AND FRITS

## INLINE-FILTER AND POROMET FRITS

### INFO:

All **Applied Research** InLine-filters are manufactured to give you the best filter capacity in order to avoid contamination of your valuable column. We offer our inlet-filters in different versions. Biocompatible with PEEK housing and your choice of PAT or Ti filter (PEEK encased). Our SS InLine-filter will give you choices of diameters of the filter disc. Use 2 mm diameter filters for low volume applications with 1 or 2 mm ID columns.. For standard analytical columns we offer the large-surface filter disc with 0.125" diameter.

#### BIOCOMPATIBLE INLINE-FILTER

- 227.1.0.125-050 InLine-filter, PEEK, complete, PAT frit 0.125", PEEK encased, 5 µm pore size
- 227.1.0.188-050 InLine-filter, PEEK, complete, PAT frit 0.188", PEEK encased, 5 µm pore size
- 227.7.0.125-020 InLine-filter, PEEK, complete, Ti frit 0.125", PEEK encased, 2 µm pore size
- 227.7.0.188-020 InLine-filter, PEEK, complete, Ti frit 0.188", PEEK encased, 2 µm pore size
- 227.0.0.000 InLine-filter, PEEK, complete body only
- 227.0.1.000 InLine-filter, PEEK, male body only
- 227.0.2.000 InLine-filter, PEEK, female body only



- 228.1.0.188-050 InLine-filter, PEEK, male connector, complete, PAT frit 0.188", PEEK encased, 5 µm pore size
- 228.1.0.188-100 InLine-filter, PEEK, male connector, complete, PAT frit 0.188", PEEK encased, 10 µm pore size
- 228.7.0.188-005 InLine-filter, PEEK, male connector, complete, Ti frit 0.188", PEEK encased, 0.5 µm pore size
- 228.7.0.188-020 InLine-filter, PEEK, male connector, complete, Ti frit 0.188", PEEK encased, 2 µm pore size
- 228.0.0.000 InLine-filter, PEEK, male connector, complete body only
- 227.0.1.000 InLine-filter, PEEK, male body only
- 228.0.2.000 InLine-filter, PEEK, male connector, female body only

#### POROMET FRITS

P/N	Diameter in		Thickness in		Pore size in
	Inch	mm	Inch	mm	µm
14.787.67.020-01	0.787	20	0.067	1.7	2
14.787.67.050-01	0.787	20	0.067	1.7	5
14.24.17.005-00	0.945	24	0.067	1.7	5
14.24.19.300-00	0.945	24	0.075	1.9	300
14.54.17.002-00	2.126	54	0.064	1.7	2
14.54.19.002-00	2.126	54	0.075	1.9	2
14.54.50.002-00	2.126	54	0.197	5.0	2
14.54.50.002-01	2.126	54	0.197	5.0	2
14.83.50.005-00	3.268	83	0.197	5.0	5
14.107.50.002-01	4.213	107	0.197	5.0	2

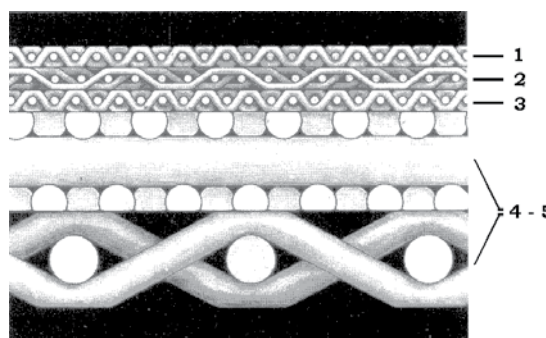

- 1) Cloth with nominal pore opening
- 2) Filter cloth
- 3) Drain area
- 4 - 5) Support Cloth

Poromet stainless steel frits are developed by one of the leading woven stainless steel cloth manufacturers for **Applied Research**. This filter disc can be used for large bore columns or large inlet filters. It provides a mechanical stable construction, where 5 different layers of filter cloth are sintered together. Filter discs will be cut to the size requested from larger sheets.

**Please Note:** Other dimensions and materials are available on request.

# COLUMNS

## PEEK COLUMNS

### INFO:

Applied Research PEEK columns are extruded from Victrex PEEK. We choose to add graphite in order to achieve a shiny black surface. Manufacturing of columns from the crude tube is made by the finest machines available on the market. PAT frits with 5 µm porosity will keep the packing in place. The inside of the columns is untreated and receives its mirror-like image through our careful extrusion method. Slurry reservoirs and packing adapters are manufactured of PEEK as well. This guarantees a biocompatible packing from the very start.



#### PEEK COLUMNS 2.1 MM ID (1/4" OD)

33.021.0030-01	Column, PEEK, 30 x 2.1 mm ID, 5 µm, complete
33.021.0050-01	Column, PEEK, 50 x 2.1 mm ID, 5 µm, complete
33.021.0100-01	Column, PEEK, 100 x 2.1 mm ID, 5 µm, complete
33.021.0150-01	Column, PEEK, 150 x 2.1 mm ID, 5 µm, complete
33.021.0250-01	Column, PEEK, 250 x 2.1 mm ID, 5 µm, complete
33.021.0300-01	Column, PEEK, 300 x 2.1 mm ID, 5 µm, complete
33.021.0001-51	Column, PEEK, endfitting for 2.1 mm ID columns
33.021.0002-51	Column, PEEK, PAT replacement frit 5 µm, for 2.1 mm ID PEEK columns
33.021.0010-51	Column, PEEK, packing adapter for 2.1 mm ID PEEK columns, 1/4"-28 to 1/2"-20
33.021.0011-51	Column, PEEK, packing seal for 2.1 mm ID PEEK columns
33.021.9250-01	Column, PEEK, slurry reservoir for 2.1 mm PEEK column, 250 mm length, complete

#### PEEK COLUMNS 4.6 MM ID (1/2" OD)

33.046.0030-01	Column, PEEK, 30 x 4.6 mm ID, 5 µm, complete
33.046.0050-01	Column, PEEK, 50 x 4.6 mm ID, 5 µm, complete
33.046.0100-01	Column, PEEK, 100 x 4.6 mm ID, 5 µm, complete
33.046.0125-01	Column, PEEK, 125 x 4.6 mm ID, 5 µm, complete
33.046.0150-01	Column, PEEK, 150 x 4.6 mm ID, 5 µm, complete
33.046.0250-01	Column, PEEK, 250 x 4.6 mm ID, 5 µm, complete
33.046.0300-01	Column, PEEK, 300 x 4.6 mm ID, 5 µm, complete
33.046.0001-51	Column, PEEK, endfitting for 4.6 mm ID PEEK columns
33.046.0003-51	Column, PEEK, PAT replacement frit 5 µm, for 4.6 mm ID PEEK columns
33.046.0010-51	Column, PEEK, packing adapter for 4.6 mm ID PEEK columns, 1/2"-20 to 5/8"-18
33.046.0011-51	Column, PEEK, packing seal for 4.6 mm ID PEEK columns
33.046.9300-01	Column, PEEK, slurry reservoir for 4.6 mm PEEK column, 300 mm length, complete

#### PEEK COLUMNS 7.5 MM ID (5/8" OD)

33.075.0030-01	Column, PEEK, 30 x 7.5 mm ID, 5 µm, complete
33.075.0050-01	Column, PEEK, 50 x 7.5 mm ID, 5 µm, complete
33.075.0100-01	Column, PEEK, 100 x 7.5 mm ID, 5 µm, complete
33.075.0150-01	Column, PEEK, 150 x 7.5 mm ID, 5 µm, complete
33.075.0250-01	Column, PEEK, 250 x 7.5 mm ID, 5 µm, complete
33.075.0300-01	Column, PEEK, 300 x 7.5 mm ID, 5 µm, complete
33.075.0001-51	Column, PEEK, endfitting for 7.5 mm ID columns
33.075.0003-51	Column, PEEK, PAT replacement frit 5 µm, for 7.5 mm ID PEEK columns
33.075.0007-51	Column, PEEK, frit spacer for 7.5 mm ID column
33.075.0010-51	Column, PEEK, packing adaptor 7.5 mm ID column, 5/8"-18
33.075.0011-51	Column, PEEK, packing seal for 7.5 mm ID columns
33.075.9600-01	Column, PEEK, slurry reservoir for 7.5 mm column, 600 mm length, complete

#### PEEK ANALYTICAL PRE-COLUMNS 3.0 MM ID (8 MM ACTIVE LENGTH)

33.030.0080-91	Column, PEEK, In-Line guard column, complete
33.030.0080-96	Column, PEEK, guard cartridge holder nut
33.030.0080-97	Column, PEEK, guard cartridge holder insert
33.030.0080-92	Column, PEEK, guard cartridge 8 mm x 3 mm ID
33.030.0080-93	Column, PEEK, PAT replacement frit 5 µm, for 3.0 mm ID PEEK guard column

# COLUMNS

## SS COLUMNS

### INFO:

The line of [Applied Research](#) SS columns are manufactured from High quality SS 316 tubes with a mirror-like inside surface. We do not touch or treat this inside surface in order to keep the high performance of our columns. Easy to pack - easy to close. No hassle.

#### ANALYTICAL SS COLUMNS 2.1 MM ID

Description	0.5 µm fritcap Part Number	2.0 µm fritcap Part Number
Column, SS, 50 x 2.1 mm ID, complete	31.021.0050-05	31.021.0050-20
Column, SS, 75 x 2.1 mm ID, complete	31.021.0075-05	31.021.0075-20
Column, SS, 100 x 2.1 mm ID, complete	31.021.0100-05	31.021.0100-20
Column, SS, 150 x 2.1 mm ID, complete	31.021.0150-05	31.021.0150-20
Column, SS, 250 x 2.1 mm ID, complete	31.021.0250-05	31.021.0250-20
Column, SS, 300 x 2.1 mm ID, complete	31.021.0300-05	31.021.0300-20

#### Replacement parts 2.1 mm SS columns

Column, SS, frit cap 2.1 mm ID column, 0.5 µm	31.021.0003-05
Column, SS, frit cap 2.1 mm ID column, 2.0 µm	31.021.0003-20
Column, SS, packing adaptor 2.1 mm ID column	31.021.0010-51

#### ANALYTICAL SS COLUMNS 4.0 MM ID

Description	0.5 µm fritcap Part Number	2.0 µm fritcap Part Number
Column, SS, 50 x 4.0 mm ID, complete	31.040.0050-05	31.040.0050-20
Column, SS, 75 x 4.0 mm ID, complete	31.040.0075-05	31.040.0075-20
Column, SS, 100 x 4.0 mm ID, complete	31.040.0100-05	31.040.0100-20
Column, SS, 150 x 4.0 mm ID, complete	31.040.0150-05	31.040.0150-20
Column, SS, 250 x 4.0 mm ID, complete	31.040.0250-05	31.040.0250-20
Column, SS, 300 x 4.0 mm ID, complete	31.040.0300-05	31.040.0300-20

#### Replacement parts 4.0 mm SS columns

Column, SS, frit cap 4.0 mm ID column, 0.5 µm	31.040.0003-05
Column, SS, frit cap 4.0 mm ID column, 2.0 µm	31.040.0003-20
Column, SS, packing adaptor 4.0 and 4.6 mm ID column	31.040.0010-51



# COLUMNS

## SS COLUMNS

### INFO:



#### ANALYTICAL SS COLUMNS 4.6 mm ID

Description	0.5 µm fritcap Part Number	2.0 µm fritcap Part Number
Column, SS, 20 x 4.6 mm ID, complete	31.046.0020-05	31.046.0020-20
Column, SS, 30 x 4.6 mm ID, complete	31.046.0030-05	31.046.0030-20
Column, SS, 50 x 4.6 mm ID, complete	31.046.0050-05	31.046.0050-20
Column, SS, 75 x 4.6 mm ID, complete	31.046.0075-05	31.046.0075-20
Column, SS, 100 x 4.6 mm ID, complete	31.046.0100-05	31.046.0100-20
Column, SS, 125 x 4.6 mm ID, complete	31.046.0125-05	31.046.0125-20
Column, SS, 150 x 4.6 mm ID, complete	31.046.0150-05	31.046.0150-20
Column, SS, 200 x 4.6 mm ID, complete	31.046.0200-05	31.046.0200-20
Column, SS, 250 x 4.6 mm ID, complete	31.046.0250-05	31.046.0250-20
Column, SS, 300 x 4.6 mm ID, complete	31.046.0300-05	31.046.0300-20

#### Replacement parts 4.6 mm SS columns

Column, SS, frit cap 4.6 mm ID column, 0.5 µm	31.046.0003-05
Column, SS, frit cap 4.6 mm ID column, 2.0 µm	31.046.0003-20
Column, SS, packing adaptor 4.0 and 4.6 mm ID column	31.040.0010-51

#### SEMI-PREPARATIVE SS COLUMNS 7.8 mm ID

Description	0.5 µm fritcap Part Number	2.0 µm fritcap Part Number
Column, SS, 50 x 7.8 mm ID, complete	31.078.0050-05	31.078.0050-20
Column, SS, 300 x 7.8 mm ID, complete	31.078.0300-05	31.078.0300-20

#### Replacement parts 7.8 mm SS columns

Column, SS, frit cap 7.8 mm ID column, 0.5 µm	31.078.0003-05
Column, SS, frit cap 7.8 mm ID column, 2.0 µm	31.078.0003-20
Column, SS, packing adaptor 7.8 and 10 mm ID column	31.0780010-51

#### SEMI-PREPARATIVE SS COLUMNS 10 mm ID

Description	0.5 µm fritcap Part Number	2.0 µm fritcap Part Number
Column, SS, 10 x 10 mm ID, complete	31.100.0010-05	31.100.0010-20
Column, SS, 30 x 10 mm ID, complete	31.100.0030-05	31.100.0030-20
Column, SS, 50 x 10 mm ID, complete	31.100.0050-05	31.100.0050-20
Column, SS, 100 x 10 mm ID, complete	31.100.0100-05	31.100.0100-20
Column, SS, 150 x 10 mm ID, complete	31.100.0150-05	31.100.0150-20
Column, SS, 250 x 10 mm ID, complete	31.100.0250-05	31.100.0250-20
Column, SS, 500 x 10 mm ID, complete	31.100.0500-05	31.100.0500-20

#### Replacement parts 10 mm SS columns

Column, SS, frit cap 10 mm ID column, 0.5 µm	31.100.0003-05
Column, SS, frit cap 10 mm ID column, 2.0 µm	31.100.0003-20
Column, SS, packing adaptor 7.8 and 10 mm ID column	31.0780010-51



# COLUMNS

## SS COLUMNS

INFO:

### SEMI-PREPARATIVE SS COLUMNS 22 MM ID

Description	0.5 µm fritcap Part Number	2.0 µm fritcap Part Number
Column, SS, 30 x 22 mm ID, complete	31.220.0030-05	31.220.0030-20
Column, SS, 50 x 22 mm ID, complete	31.220.0050-05	31.220.0050-20
Column, SS, 100 x 22 mm ID, complete	31.220.0100-05	31.220.0100-20
Column, SS, 150 x 22 mm ID, complete	31.220.0150-05	31.220.0150-20
Column, SS, 250 x 22 mm ID, complete	31.220.0250-05	31.220.0250-20
Column, SS, 300 x 22 mm ID, complete	31.220.0300-05	31.220.0300-20
Column, SS, 500 x 22 mm ID, complete	31.220.0500-05	31.220.0500-20

### Replacement parts 22 mm SS columns

Column, SS, frit cap 22 mm ID column, 0.5 µm	31.220.0003-05
Column, SS, frit cap 22 mm ID column, 2.0 µm	31.220.0003-20
Column, SS, packing adaptor 22 mm ID column	31.220.0010-51

### COMPRESSION FITTINGS 1/4" x 4.6 MM

31.046.0000-71	Column, SS, endfitting 1/4" x 4.6 mm, compression, without frit
31.046.0005-71	Column, SS, endfitting 1/4" x 4.6 mm, compression, 0.5 µm frit
31.046.0020-71	Column, SS, endfitting 1/4" x 4.6 mm, compression, 2.0 µm frit
31.046.0050-71	Column, SS, endfitting 1/4" x 4.6 mm, compression, 5.0 µm frit

### UNIVERSAL COLUMN COUPLER

53.1.2310.001	Coupler, PEEK, universal, 0.13 mm ID, red PP sleeve
53.1.2310.002	Coupler, PEEK, universal, 0.18 mm ID, yellow PP sleeve
53.1.2310.003	Coupler, PEEK, universal, 0.25 mm ID, blue PP sleeve
53.1.2310.004	Coupler, PEEK, universal, 0.50 mm ID, orange PP sleeve

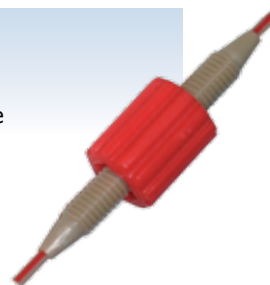

### COLUMN ENDSTOPPERS

53.11.200400-00	Plug, Nylon, column endstopper white, 10-32
53.11.200400-01	Plug, Nylon, column endstopper red, 10-32
53.11.200400-02	Plug, Nylon, column endstopper yellow, 10-32
53.11.200400-03	Plug, Nylon, column endstopper blue, 10-32
53.11.200400-05	Plug, Nylon, column endstopper green, 10-32
53.11.200400-07	Plug, Nylon, column endstopper black, 10-32





# TOOLS

## INFO:

When working with tubing it is most important to have carefully cut tube ends. This is imperative for making a good connection. To achieve a perpendicular cut, we suggest you use our Clean-Cut tubing cutter. We recommend to change the blade on a regular basis in order to have a sharp cutting blade, which will provide you with the best cut available.

### CUTTER FOR POLYMER TUBING

70.0010.001	Tool, Clean-Cut Tubing Cutter (delivered in plastic case with 1 spare blade)
70.0010.002	Tool, replacement blade for 70.0010.001
70.0020.001	Tool, Guillotine Cutter for polymer tubing
70.0020.002	Tool, replacement blade for 70.0020.001

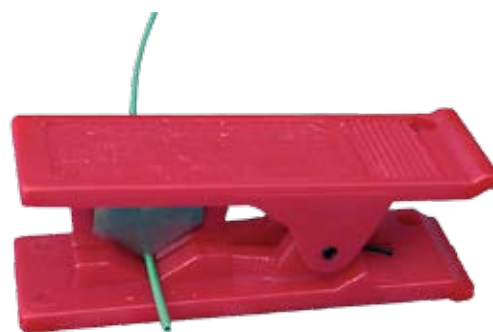
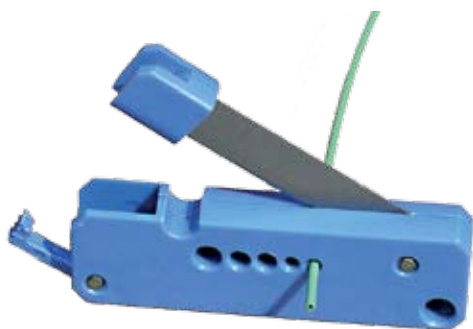

Cutting metal tubing is one of the most difficult tasks in chromatography. We recommend for critical connections to use our precut stainless steel tubing. The tools offered by [Applied Research](#) will give you a satisfactory cut of metal tubing which can be used in non-critical connections. Cutting tools offered by [Applied Research](#) are not ment to cut the metal tubing all the way, but to score the tube in order to break it. This way you will not close the inner diameter of the tube. Use our file for cleaning of the tube.

### CUTTER FOR METAL TUBING

70.0030.001	Tool, tubing cutter for metal tubing
70.0030.002	Tool, replacement cutting wheel for 70.0030.001
70.0050.001	Tool, Tubing Plier for metal tubing

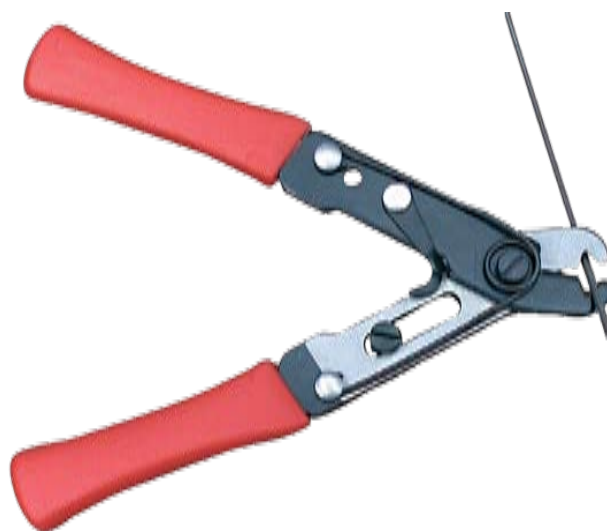

Silica tubing is not cut, but scored to break. Use the [Applied Research](#) Tungsten Carbide knife to score your fused silica tube easy and convenient.

### CUTTER FOR SILICA TUBING

70.0070.001	Tool, Tungsten Carbide Glass Knife
70.0070.002	Tool, Tungsten Carbide Glass Knife, replacement blade

# TOOLS

## INFO:

To keep your tubing in place is not always easy. This is why [Applied Research](#) recommends tube holders. The tubing knees will give you the right bend of your PEEK tubing, preventing close diameters, which do have a negative effect on the mechanical stability of your PEEK tubing.

The [Applied Research](#) tubing holder will hold the tubing in the beaker and bottle. You will be surprised to see how the tube holder makes your lab-life easier. For use with 1/16" or 1/8" tubing.

### TUBE HOLDERS

74.0010.090	Tool, Tubing knee 90°
74.0010.180	Tool, Tubing knee 180°
74.0001.001	Tool, tubing holder



### STANDARD TOOLS

P/N	Description
71.375.434.01	Tool, open wrench 3/8" x 7/16"
71.250.312.01	Tool, open wrench 1/4 x 5/16"
71.803.01	Tool, Pincers
71.802.01	Tool, file
71.806.01	Tool, tweezers
71.819.01	Tool, drill set incl. holder



P/N	Description
71.0080.01	Tool, Valvetool



# ACCESSORIES

## INFO:

All of [Applied Research](#) bottles are safety coated for protection of your solvent and for your own safety. The coatings has UV-cutoff at 350 nm and will protect your valuable solvent. If the bottle is dropped, the glass will break, the coating will prevent solvent from leaking. This will provide you with sufficient time to move the bottle and its contents to a safe place.

All of [Applied Research](#) GasTight tubing and accessories provide the perfect alternative for the transport of degassed solvents. The GasTight tube consist of two different layers of tubing. The inside is made of PTFE, which is chemically highly stable, but possesses micro-pores. The outer liner of PVDF will not have any open pores, but is chemically unstable to many solvents. Use the Fitting Kit with the Kel-F insert to make the perfect connection of your Gas-Tight tube.

To prevent bubbles in the detector cell, we recommend the use [Applied Research](#) variable back-pressure regulator. Even degassed mobile phase can 'outgas' when expanding after the columns outlet. With the proper backpressure this effect can be avoided. Please note to not overpressure your detector cell. See your detector manual or contact your local instruments supplier for guidance.

## SOLVENT RESERVOIRS

### BOTTLES AND BOTTLE KITS

73.0100.00	Bottle, Glass, safety-coated 1 L with solid cap
73.0100.15	Bottle, Glass, 1 L with PTFE bottle cap
73.0200.00	Bottle, Glass, safety-coated 2 L with solid cap
73.0200.15	Bottle, Glass, 2 L with PTFE bottle cap

### BOTTLE CAPS

73.0000.01	Bottlecap, PE, solid, GL-45
73.0000.10	Bottlecap, PE, modified for PTFE insert, GL-45
73.0000.15	Bottlecap, PE, including PTFE insert, GL-45

## GASTIGHT TUBING

71.003.125.015	GasTight, tubing 1/8" x 1.5 mm ID
71.003.005	GasTight, PP, fittings kit (2 complete sets)
71.003.001	GasTight, Kel-F, Insert

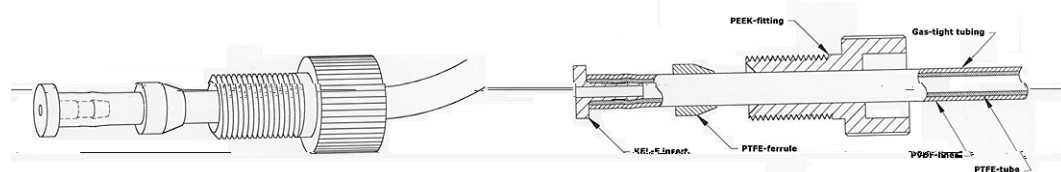

## VARIABLE BACKPRESSURE REGULATOR

99.39021.00	Backpressure Regulator, variable, 0 - 7 bar (0 - 100 psi)
99.39022.00	Backpressure Regulator, variable, 7 - 20 bar (100 - 300 psi)
99.39023.00	Backpressure Regulator, variable, 20 - 45 bar (300 - 600 psi)
99.39024.00	Backpressure Regulator, variable, 45 - 100 bar (600 - 1500 psi)

# ACCESSORIES

## INFO:

Use the [Applied Research Solvent Recycler](#) to save up to 75% of valuable solvents in your day-to-day isocratic analysis. We even offer our Solvent Recycler with a second valve, which can be used as wash valve for easy and consent solvent change.

### SOLVENT RECYCLER 7206

#### SOLVENT RECYCLER 7206

91.100.01	Solvent Recycler, complete, 100 V
91.110.01	Solvent Recycler, complete, 110 V
91.230.01	Solvent Recycler, complete, 230 V
91.000.03	Solvent Recycler, Replacement Valve Kel-F

#### SOLVENT RECYCLER WITH WASH-VALVE

91.100.02	Solvent Recycler, incl. second wash-valve, complete, 100 V
91.110.02	Solvent Recycler, incl. second wash-valve, complete, 110 V
91.230.02	Solvent Recycler, incl. second wash-valve, complete, 230 V
91.000.03	Solvent Recycler, Replacement Valve Kel-F

### DEGASSER 750 SERIES

#### DEGASSER

91.750.01	Degasser, LV analytical, 1-channel,, 90 - 240 V
91.750.02	Degasser, LV analytical, 2-channel,, 90 - 240 V
91.750.03	Degasser, LV analytical, 3-channel,, 90 - 240 V
91.750.04	Degasser, LV analytical, 4-channel,, 90 - 240 V

The [Applied Research degasser](#) will give you a simple and easy way of on-line degassing of solvents. Our analytical versions are equipped with our internal low volume chamber of 440 µl (flow up to 10 mL/Min), LCD display of vacuum CPU controlled vacuum level management. We also offer degassing systems for micro and semi-preparative application on request. Wetted parts are made of PTFE, ETFE and PPS. All degassers can be delivered with validation output port.

### CHECKVALVE

99.FLPPB-1.5	Checkvalve, Delrin, Luer to Luer, 0.1 bar
--------------	---

# ACCESSORIES

## VALVES

### INFO:

Applied Research also offers a line of manual injection and switching valves. These valves are manufactured to high precision to provide you with the best results possible. All injection valves are provided with a built-in event marker, and are designed for PSR (pressure shock reduction).

### INJECTION VALVES

89.1.0100.20	Injection valve, PEEK, analytical
89.6.0100.20	Injection valve, SS, analytical

Model no.	89.1.0100.20	89.6.0100.20
<b>Max Pressure</b>	20 MPa	30 MPa
<b>Liquid contact material</b>	PEEK, ceramics	SS316, PEEK
<b>Needle Port material</b>	PEEK	SS316
<b>Stator material</b>	Ceramic	SS316
<b>Rotor seal material</b>	PEEK	PEEK
<b>Flow path diameter</b>	1.0 mm	0.5 mm
<b>Internal volume</b>	19.5 µl	2.4 µl

All valves will be delivered incl. 10-32 fittings, ferrules for 1/16" capillaries and wrenches for tube connection.

### REPLACEMENT PARTS

#### Figure

1	Valve, PEEK, PEEK stator for 89.1.0100.20	89.1.0100.91
2	Valve, SS, SS stator for 89.6.0100.20	89.6.0100.91
3	Valve, PEEK, PEEK face packing for 89.1.0100.20	89.1.0100.95
4	Valve, PEEK, ceramic stator face for 89.1.0100.20	89.1.0100.93
5	Valve, SS, ceramic stator face for 89.6.0100.20	89.6.0100.93
6	Valve, PEEK, PEEK rotor seal for 89 injector series	89.1.0100.92
7	Valve, PEEK, PTFE needle seal for 89 injector series	89.1.0100.94
8	Valve, PEEK, setscrew 3.0 mm, 10 pack	89.1.0100.97
9	Valve, PEEK PTFE needle port for 89 injector series	89.1.0100.96
10	Valve, SS, SS #22 needle, 0.5 mm ID	89.6.0100.98
11	Valve, PEEK, PEEK/PTFE needle #22, 0.5 mm ID	89.1.0100.98
12	Tool, open wrench 6 x 8 mm	71.060.080
13	Tool, hex-wrench (1.5 - 2.0 - 3.0 mm)	71.500.030

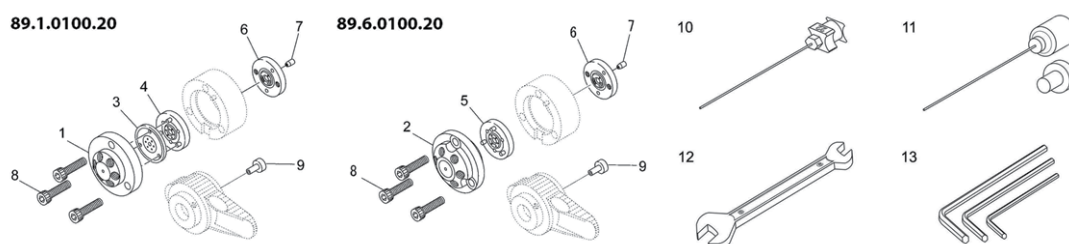



# ACCESSORIES

## SWITCHING VALVES

INFO:

### SWITCHING VALVE 4 PORT

#### 2 POSITION 4 PORT

- 89.1.0204.00 Injection valve, PEEK, analytical, 2 position 4 port (1/4"-28 connections)  
 89.6.0204.00 Injection valve, SS, analytical, 2 position 4 port

<b>Model no.</b>	89.1.0204.00	89.6.0204.00
<b>Max Pressure</b>	5 MPa	35 MPa
<b>Liquid contact material</b>	PEEK, carbon-fiber PEEK	SS316, PEEK
<b>Stator face material</b>	PEEK, SS 316	SS316
<b>Rotor seal material</b>	PEEK	PEEK
<b>Flow path diameter</b>	1.0 mm	0.5 mm
<b>Internal volume</b>	19.5 µl	2.4 µl

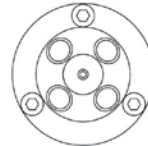

Path Diagram

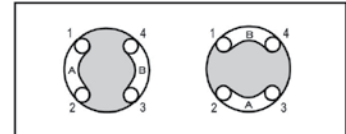

### SWITCHING VALVE 6 PORT

#### 2 POSITION 6 PORT

- 89.1.0206.00 Injection valve, PEEK, analytical, 2 position 6 port  
 89.6.0206.00 Injection valve, SS, analytical, 2 position 6 port

<b>Model no.</b>	89.1.0206.00	89.6.0206.00
<b>Max Pressure</b>	20 MPa	35 MPa
<b>Liquid contact material</b>	PEEK, ceramic	SS316, PEEK
<b>Stator face material</b>	Ceramic	SS316
<b>Rotor seal material</b>	PEEK	PEEK
<b>Flow path diameter</b>	0.6 mm	0.5 mm
<b>Internal volume</b>	5.0 µl	2.1 µl

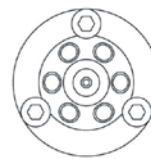

Path Diagram

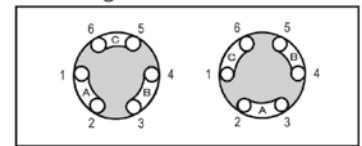

All valves will be delivered incl. fittings, ferrules and wrenches for tube connection.

### REPLACEMENT PARTS

#### Figure

1	Valve, SS, SS stator for 89.6.0206.00	89.6.0206.91
2	Valve, PEEK, PEEK stator for 89.1.0206.00	89.1.0206.91
3	Valve, PEEK, ceramic stator face for 89.1.0206.00	89.1.0206.93
4	Valve, PEEK, PEEK rotor seal for 6 port valves	89.1.0206.92
5	Valve, PEEK, setscrew 3.0 mm, 10 pack	89.1.0100.97
6	Valve, SS, SS stator for 89.6.0204.00	89.6.0204.91
7	Valve, PEEK, PEEK stator for 89.1.0204.00	89.1.0204.91
8	Valve, PEEK, carbon-fiberPEEK stator face for 89.1.0204.00	89.1.0204.93
9	Valve, SS, PEEK rotor seal for 89.6.0204.00	89.6.0204.92
10	Valve, PEEK, PEEK rotor seal for 89.1.0204.00	89.1.0204.92
11	Valve, PEEK, setscrew 2.5 mm, 10 pack	89.1.0204.97

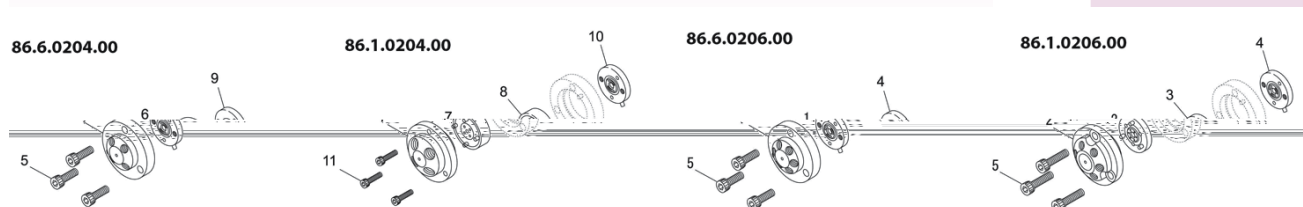

# APPENDICES

## CONVERSION TABLES AND DIAGRAMS

### GENERAL CONVERSION FACTORS

Inches to mm	Inches x 2.54 = mm
Feet to Meter	Feet x 0.3048 = Meter
Meter to feet	Meter x 3.281 = Feet
bar to psi	bar x 14.5 = psi
psi to bar	psi x 0.069 = bar
psi to KPa	psi x 6.9 = KPa

### TEMPERATURE CONVERSION

C	F
-40	-40
-30	-22
-20	-4
-10	14
0	32
5	41
10	50
20	68
25	77
30	86
35	95
37	98.6
40	104
50	122
60	140
70	158
80	176
90	194
100	212
150	302
175	347
200	392
225	437
250	482
300	572
400	752
500	932
750	1382
1000	1832

### PRESSURE CONVERSION

bar	psi	Kpa	Mpa
0,1	1.5	10	0.01
0.2	2.9	20	0.02
0.25	3.6	25	0.025
0.3	4.4	30	0.03
0.4	5.8	40	0.04
0.5	7.3	50	0.05
0.6	8.7	60	0.06
0.7	10.2	70	0.07
0.75	10.9	75	0.075
0.8	11.6	80	0.08
0.9	13.1	90	0.09
1	14.5	100	0.1
2	29.0	200	0.2
3	43.5	300	0.3
4	58.0	400	0.4
5	72.5	500	0.5
6	87.0	600	0.6
7	102	700	0.7
8	116	800	0.8
9	131	900	0.9
10	145	1000	1
20	290	2000	2
25	363	2500	2.5
30	435	3000	3
40	580	4000	4
50	725	5000	5
60	870	6000	6
70	1015	7000	7
80	1160	8000	8
90	1305	9000	9
100	1450	10000	10
500	7250	50000	50
1000	14500	100000	100

# APPENDICES

## CONVERSION TABLES AND DIAGRAMS

### LENGTH CONVERSION

mm	Inch	Inch	mm
0.064	0.0025	1/32"	0.79
0.1	0.0039	1/16"	1.59
0.13	0.005	3/32"	2.38
0.18	0.007	1/8"	3.17
0.25	0.010	1/4"	6.35
0.5	0.020	5/16"	7.94
0.75	0.030	1/2"	12.7
1	0.039	1"	25.4
1.4	0.055	12" (1 ft)	304.8
1.5	0.059		
2	0.079		
3	0.118		
4	0.157		
4.6	0.181		
5	0.197		
6.35	0.250		
10	0.394		
12.7	0.500		

**Effect of Temperature on the Permeability of PTFE (Teflon)**

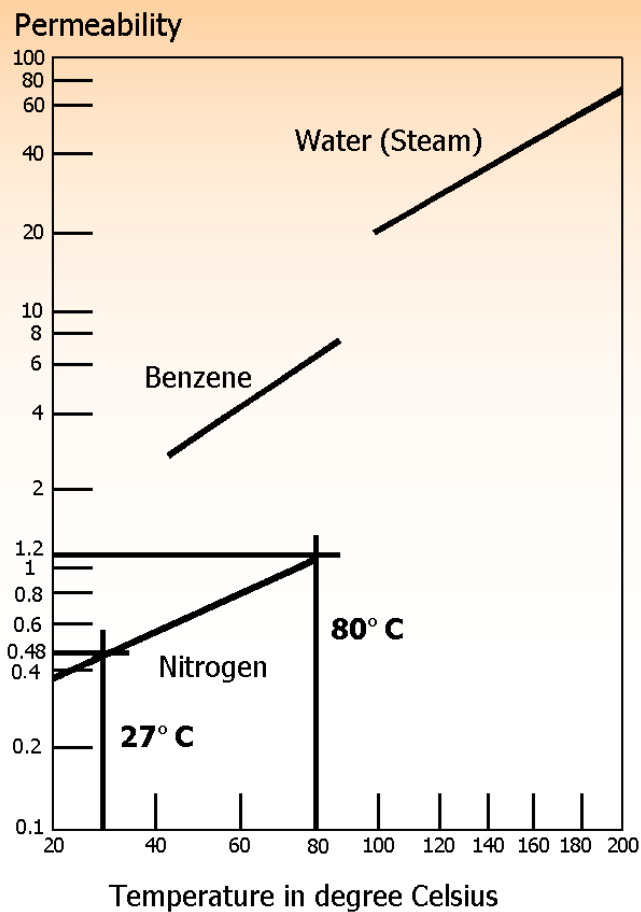

Note: Values are averages only and not for special purposes.

# APPENDICES

## CONVERSION TABLES AND DIAGRAMS

### VOLUME CHART

ID in mm	µl / cm	ID in Inch	µl / inch
0.064	0.032	0.0025	0.08128
0.10	0.078	0.0039	0.19812
0.13	0.133	0.005	0.33782
0.18	0.254	0.007	0.64516
0.25	0.49	0.010	1.2446
0.50	1.96	0.020	4.9784
0.75	4.42	0.030	11.2268
1.0	7.85	0.039	19.939
1.4	15.4	0.055	39.116
1.59	19.9	0.062	50.546

Deviations in nominal tubing volume (in µL/mm) caused by different tolerances

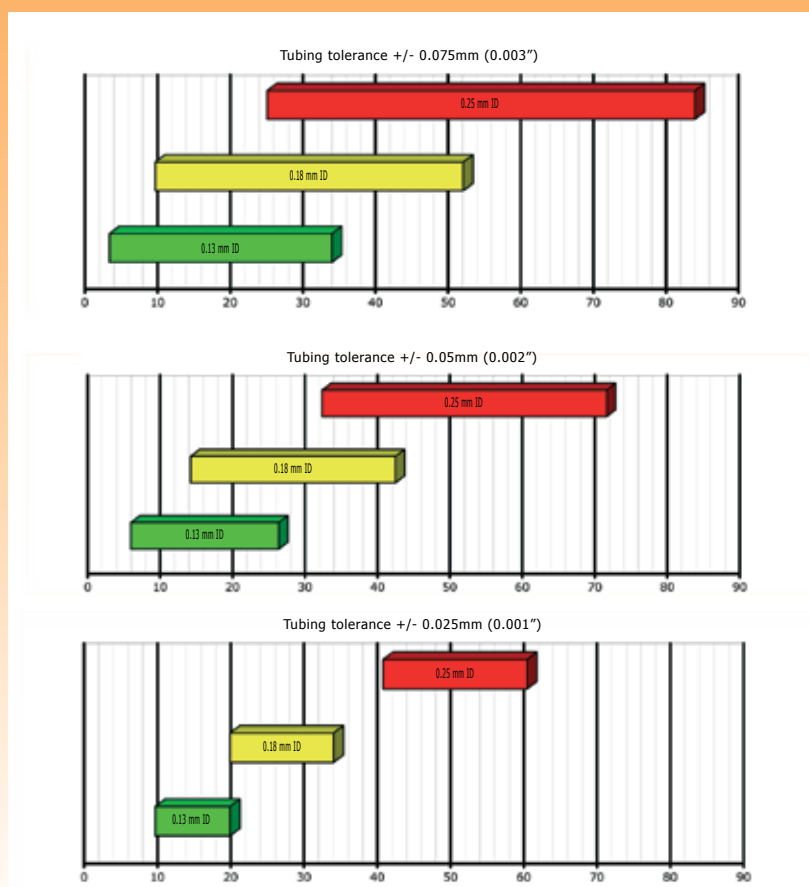

### POROUS MEDIA PARTICLE RETENTION EFFICIENCY AND PORESIZES ESTIMATES

Media Grade in micron	Calculated Pore Size in micron	Porosity % open Volume	Liquid Efficiency (µm)			Air Efficiency (µm)		
			90.0%	99.0%	99.9%	90.0%	99.0%	99.9%
0.5	5-8	12-16	1	1.7	2.2	Most Particles	0.25	0.3
1	8-11	18-22	1.5	2.2	3.3	Most Particles	0.35	0.7
2	14-16	20-25	4	5.5	9	0.3	0.6	2
5	20-25	28-32	5	8	13	0.8	2	5
10	30-42	35-40	10	16	20	4.5	8	13
20	55-65	45-55	20	26	35	8	12	20

## Contact Us

### WEBSITE

[www.appliedresearch.de](http://www.appliedresearch.de)

### GENERAL INFORMATION; CATALOG ORDERS

[info@appliedresearch.de](mailto:info@appliedresearch.de)

### VISITING ADDRESS

**Golmer Str. 18A  
DE – 13 585 Berlin  
Germany**

**Telephone: +49 – (0)30 – 37 888 754**

**Fax: +49 – (0)30 – 37 888 755**

### US SALES & SERVICE CENTER

**P.O. Box 826**

**145 Hill Street**

**Milroy, PA 17063**

**[jim.whitford@appliedresearch.de](mailto:jim.whitford@appliedresearch.de)**

**Telephone: (717) 667 - 2222**

**Fax: (717) 667 - 2282**

### CONDITIONS OF SALES AND SERVICES

Payment terms are net 30 days if not stated otherwise. Prices subject to change without notice.

### RETURNS

No returns will be accepted more than 90 days after shipment for any reason. Before 90 days, no returns will be accepted without prior authorization. If it is necessary to return material to us, please contact our Sales Department for a return authorization number and forwarding instruction. Inspect each shipment upon receipt and report shortages and incorrect or damaged material to us immediately.

Important! Damaged shipments must remain with original packaging for freight company inspection.

Returned material will be subject to a restocking charge of 20% for catalog items. Special orders cannot be returned unless defective.

### REPAIRS

For repair return authorization or informations about factory refurbishments, contact our Service Department.

### NOTICE

Applied Research Europe GmbH reserves the right to correct errors and change prices, design or specifications without notice or liability. The information in this catalog is correct to the best of our knowledge but is not guaranteed to be so. Applied Research Europe GmbH assumes no responsibility with respect thereto.

### TRADEMARKS AND REGISTERED TRADEMARKS

Delrin® is a Registered Trademark of E.I. du Pont de Nemours and Company

Kalrez® is a Registered Trademark of DuPont Dow Elastomers

Kel-F® is a Registered Trademark of 3M Company

PEEK™ is a Trademark of Victrex plc

Rheodyne® is a Registered Trademark of Rheodyne LLC

Teflon® is a Registered Trademark of E.I. du Pont de Nemours and Company

Tefzel® is a Registered Trademark of E.I. du Pont de Nemours and Company

VICI® is a Registered Trademark of Valco Instruments Co. Inc. and VICI International

Cheminert® is a Registered Trademark of Valco Instruments Co. Inc. and VICI International



## Contact Us

### WEBSITE

[www.appliedresearch.de](http://www.appliedresearch.de)

### GENERAL INFORMATION; CATALOG ORDERS

[info@appliedresearch.de](mailto:info@appliedresearch.de)

### PRICE AND DELIVERY INQUIRIES

[info@appliedresearch.de](mailto:info@appliedresearch.de)  
[helmut.muller@appliedresearch.de](mailto:helmut.muller@appliedresearch.de)

### TECHNICAL QUESTIONS

[helmut.muller@appliedresearch.de](mailto:helmut.muller@appliedresearch.de)  
[christian.wegner@appliedresearch.de](mailto:christian.wegner@appliedresearch.de)

### VISITING ADDRESS

**Golmer Str. 18A**  
**DE – 13 585 Berlin**  
**Germany**  
**Telephone: +49 – (0)30 – 37 888 754**  
**Fax: +49 – (0)30 – 37 888 755**

### US SALES & SERVICE CENTER

**P.O. Box 826**  
**145 Hill Street**  
**Milroy, PA 17063**  
**[jim.whitford@appliedresearch.de](mailto:jim.whitford@appliedresearch.de)**  
**Telephone: (717) 667 - 2222**  
**Fax: (717) 667 - 2282**

